



DAMRI

Bus papercraft

DAMRI stands Djawatan Repoeblik Angkoetan Motor Indonesia, which was formed under the Ministry of sharing in RI Makloemat No.01/DAMRI/46 dated 25 November 1946, with the main task of organizing transportation of people and goods on the road with motor vehicles. Further development as a Public Corporation (Perum), the name DAMRI remain enshrined as a brand mark of the State Owned Enterprises (SOEs) that until now still remain consistently carry out their duties as one of the service provider of transportation of people and goods by using buses and trucks.

Until now, DAMRI service network spread almost throughout the territory of the Republic of Indonesia. In conducting its business activities DAMRI urban transport services, transportation between cities, special airport transportation, freight travel, transport packages (logistics), keperintisan transport and transport across national borders.

www.wikipedia.com



This is FREE MODEL not for sale

Please read assembly instructions before cut the pattern.

Use sharp cutter and ruler to cut.

Bacalah petunjuk perakitan sebelum memotong pola

Gunakan alat pemotong yg tajam dan penggaris

legend / tanda	
	Glue / lem
	Hole/ lubang

 *Paper material
For
Green Environment*



Design by Rino Liha
rino_Gmaker4@yahoo.com

ASSEMBLY INSTRUCTION
PETUNJUK PERAKITAN

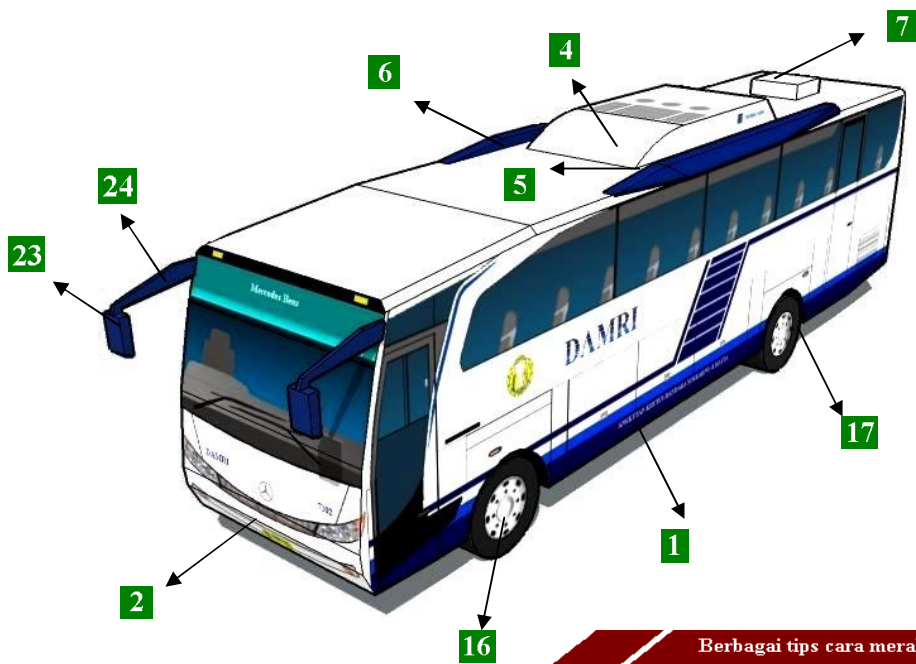
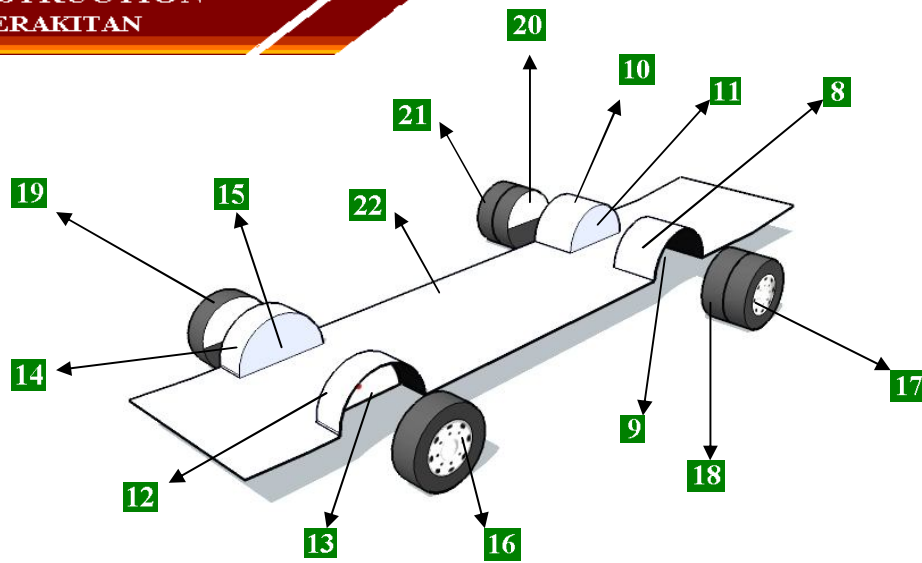

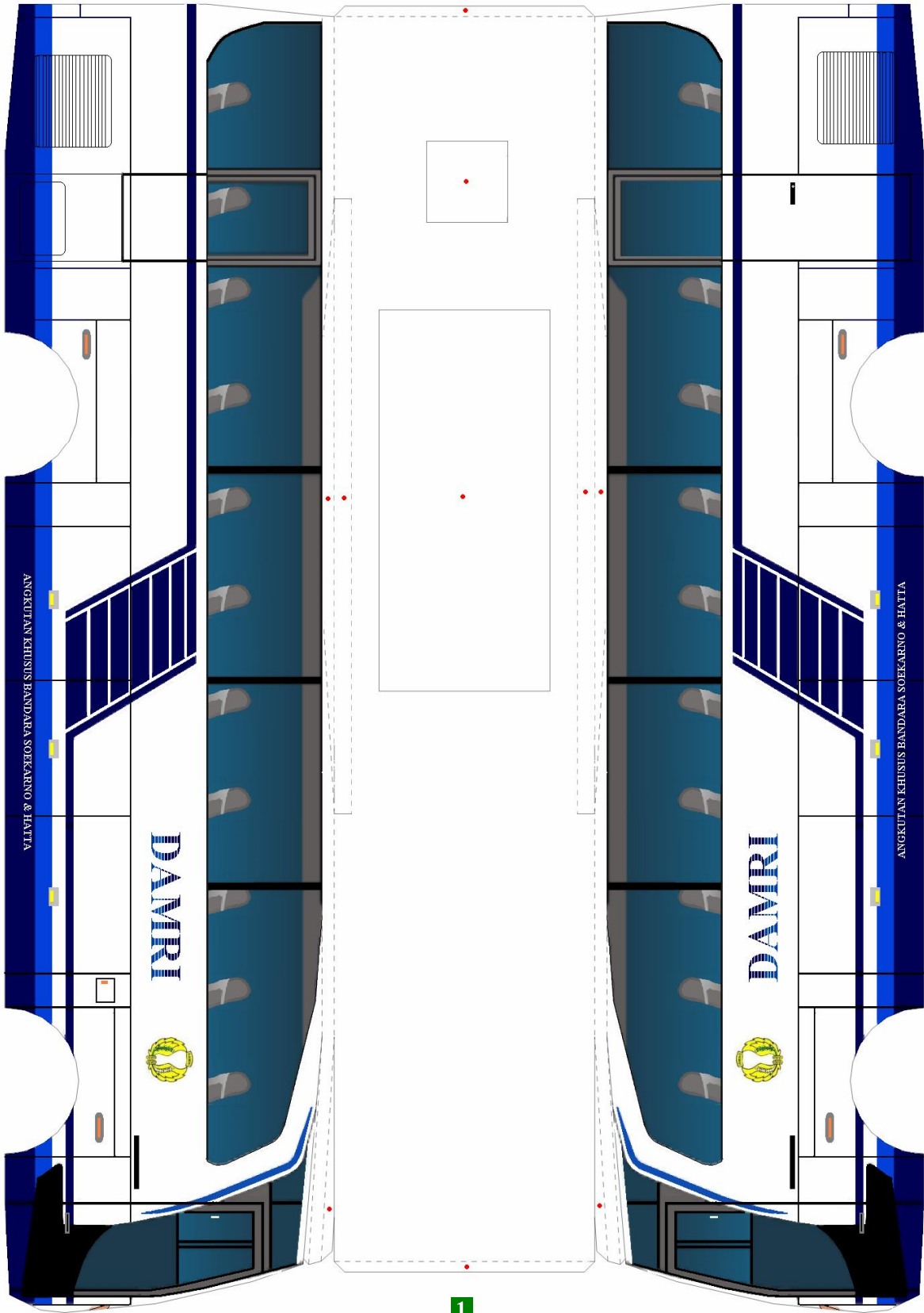

1

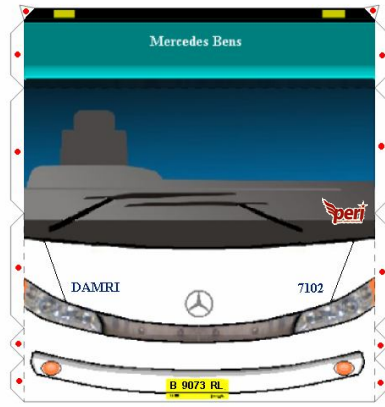
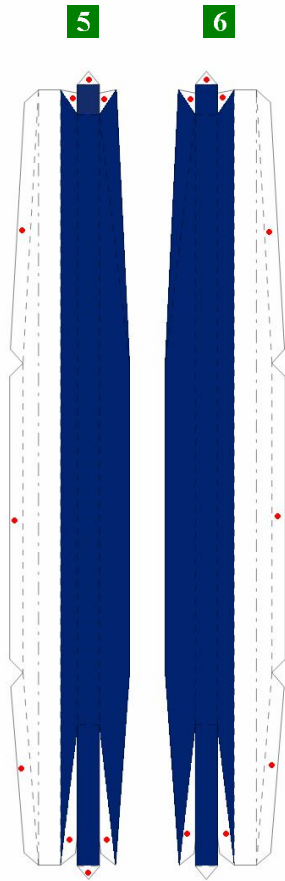

3



2



8

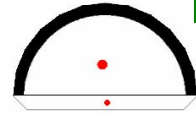

9



10

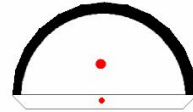

11

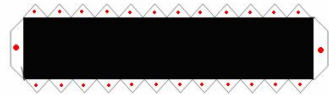

12

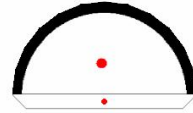

13



14

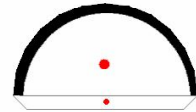

15



24

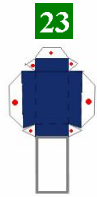

23

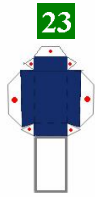

23



24

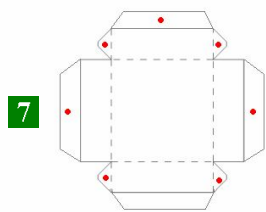

7

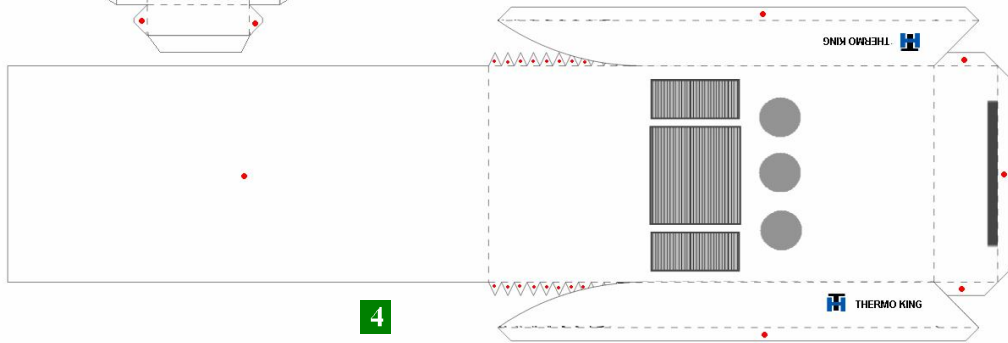

4

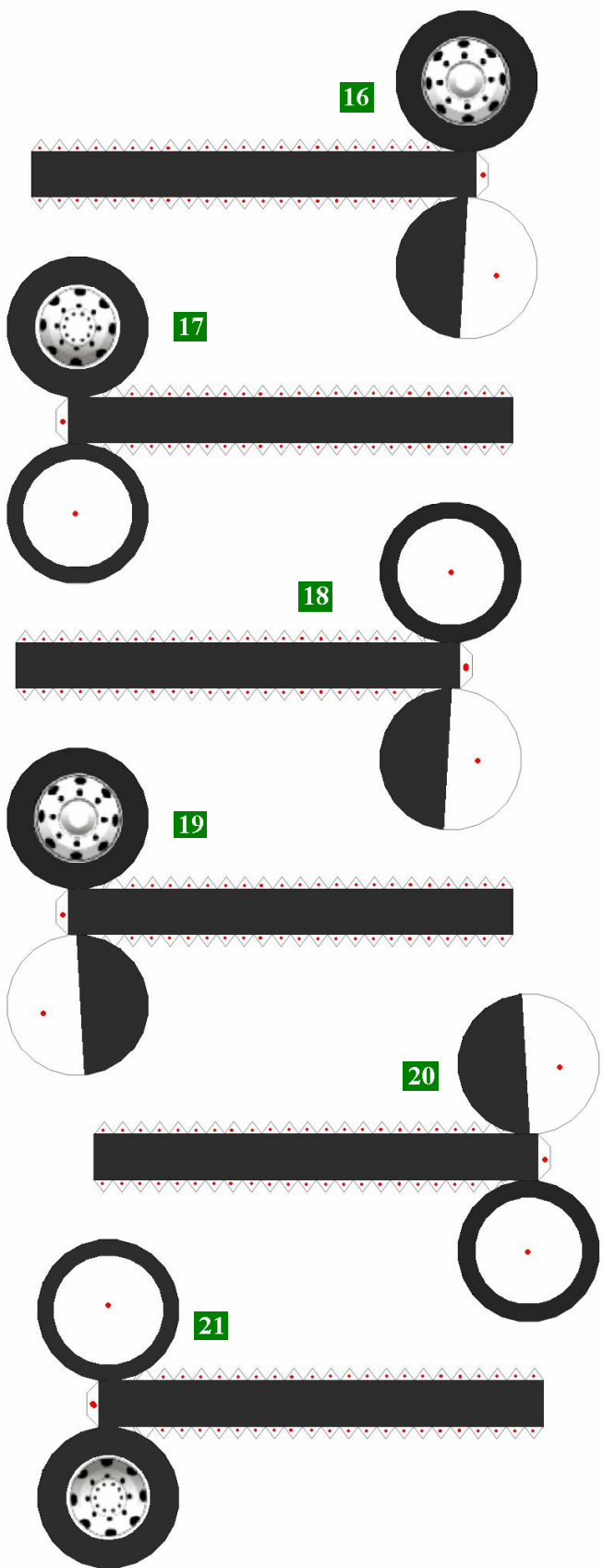

 Paper Replikasi Indonesia
 Paper Replikasi Indonesia
 PERIKRAS.COM
 design by:
 rino_gmakaner@yahoo.com
free model, not for sale