

**N1**  
NOSE SECTION LOWER HULL  
POLYFOAM  
DEPRON 5MM

**N2**  
NOSE SECTION LOWER HULL FORMER  
POLYFOAM  
DEPRON 5MM  
REAR FORMER

**N3**  
NOSE SECTION FORMER  
POLYFOAM  
DEPRON 5MM  
FRONT FORMER

**N5**  
NOSE SECTION UPPER HULL FORMER  
POLYFOAM  
DEPRON 5MM  
REAR FORMER

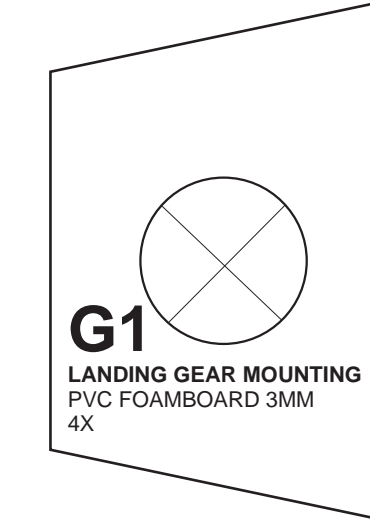

**N6**  
NOSE SECTION UPPER HULL FORMER  
POLYFOAM  
DEPRON 5MM  
FRONT FORMER

**N8**  
NOSE SECTION LOWER HULL FORMER  
POLYFOAM  
DEPRON 5MM

**G2**  
LANDING GEAR MOUNTING  
PVC FOAMBOARD 3MM

**N25**  
NOSE SECTION LOWER HULL FORMER  
POLYFOAM  
DEPRON 5MM



## Boeing 747-400 4000mm

**Specs :**  
1. Wingspan 4000mm / 157.5 inches  
2. Flying weight : target 4000 grams  
3. Wing loading :  
4. Wing cube loading :  
5. Wing Area :  
6. CG :

**Electronics**  
- 1 metal gear 9 gram servos (micro servo)

**Materials :**  
1. 5mm + 3mm Depron/ Polyfoam  
2. 3mm Plywood / PVC foam board  
3. hot glue, foam-safe glue, CA glue  
4. packing tape

**N4**  
NOSE SECTION UPPER HULL  
POLYFOAM  
DEPRON 3MM

**N7**  
NOSE SECTION LOWER HULL  
POLYFOAM  
DEPRON 3MM

**N9**  
NOSE SECTION LOWER HULL  
POLYFOAM  
DEPRON 3MM

**N10**  
NOSE SECTION LOWER HULL FORMER  
POLYFOAM  
DEPRON 3MM

**N11**  
NOSE SECTION UPPER HULL  
POLYFOAM  
DEPRON 3MM

FRONT →

← FRONT

← FRONT

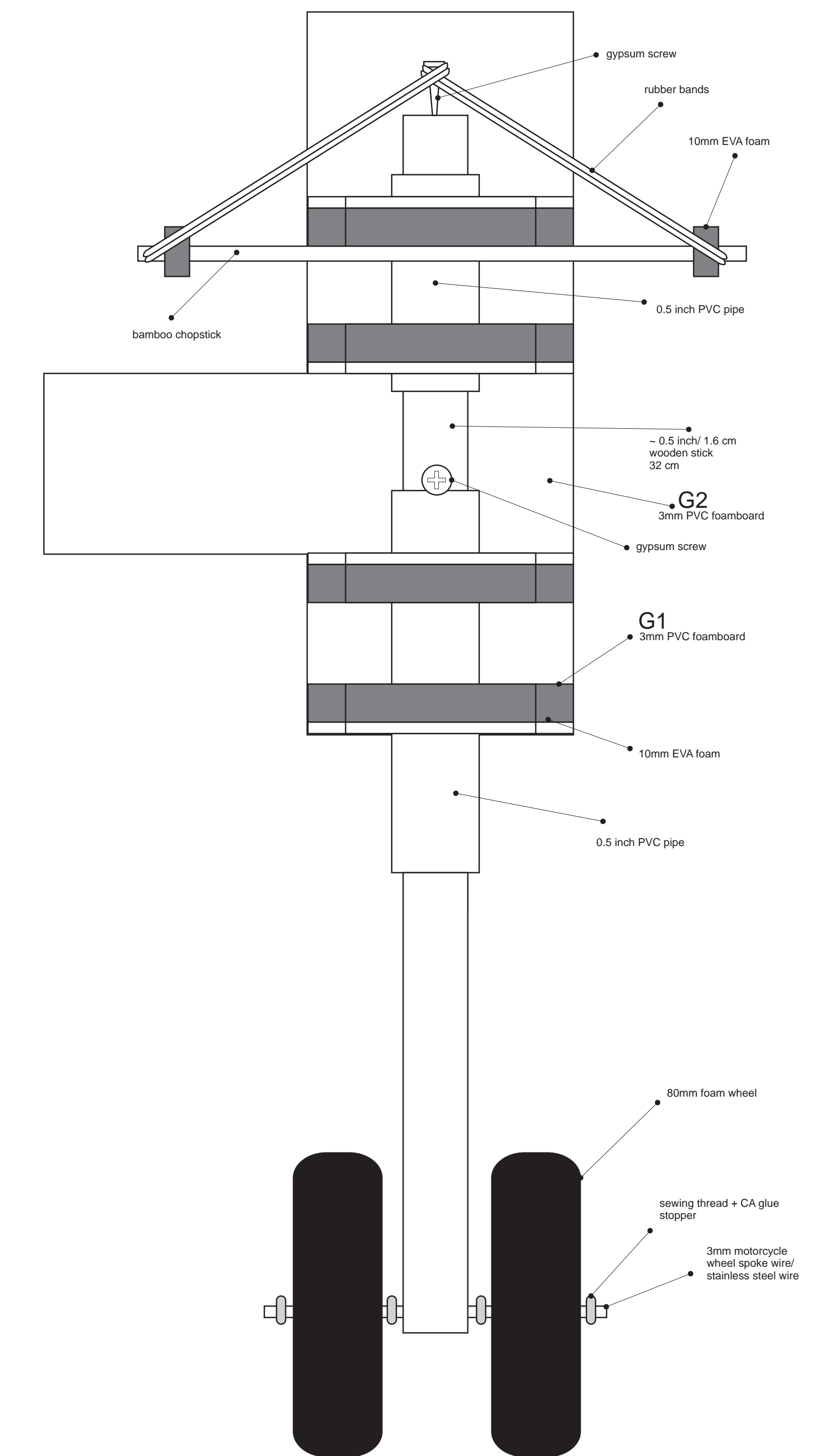



**N12**  
NOSE SECTION UPPER HULL FORMER  
POLYFOAM  
DEPRON 3MM

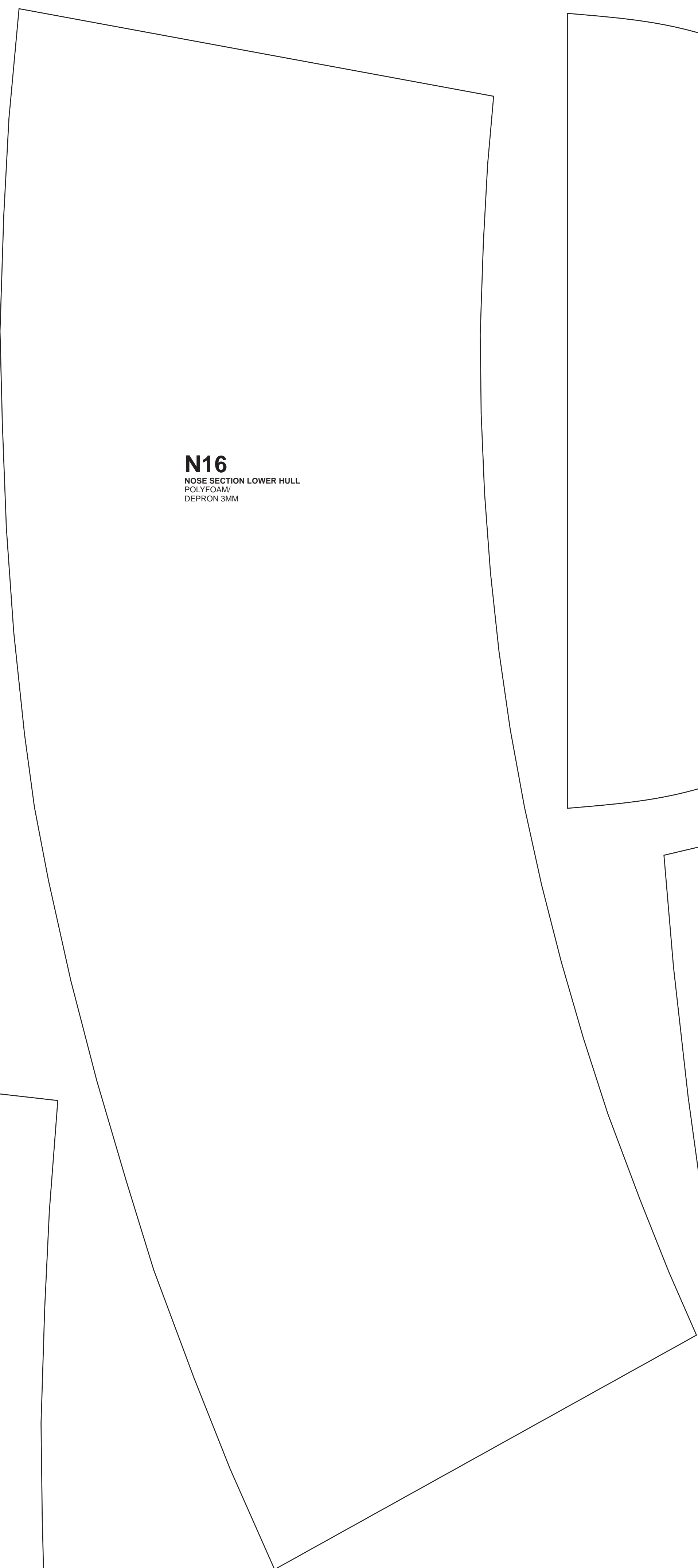

**N16**  
NOSE SECTION LOWER HULL  
POLYFOAM  
DEPRON 3MM

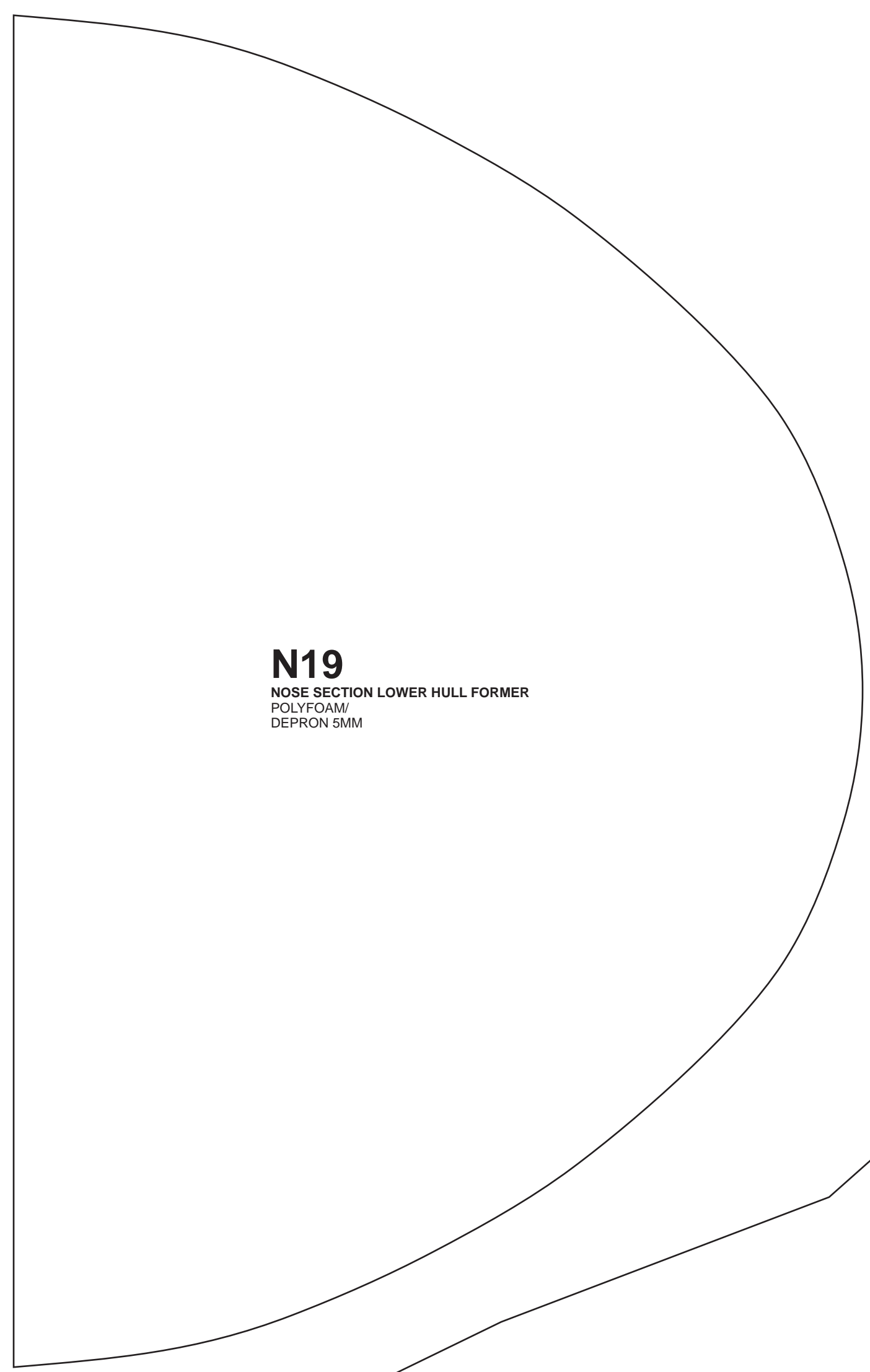

**N19**  
NOSE SECTION LOWER HULL FORMER  
POLYFOAM  
DEPRON 3MM

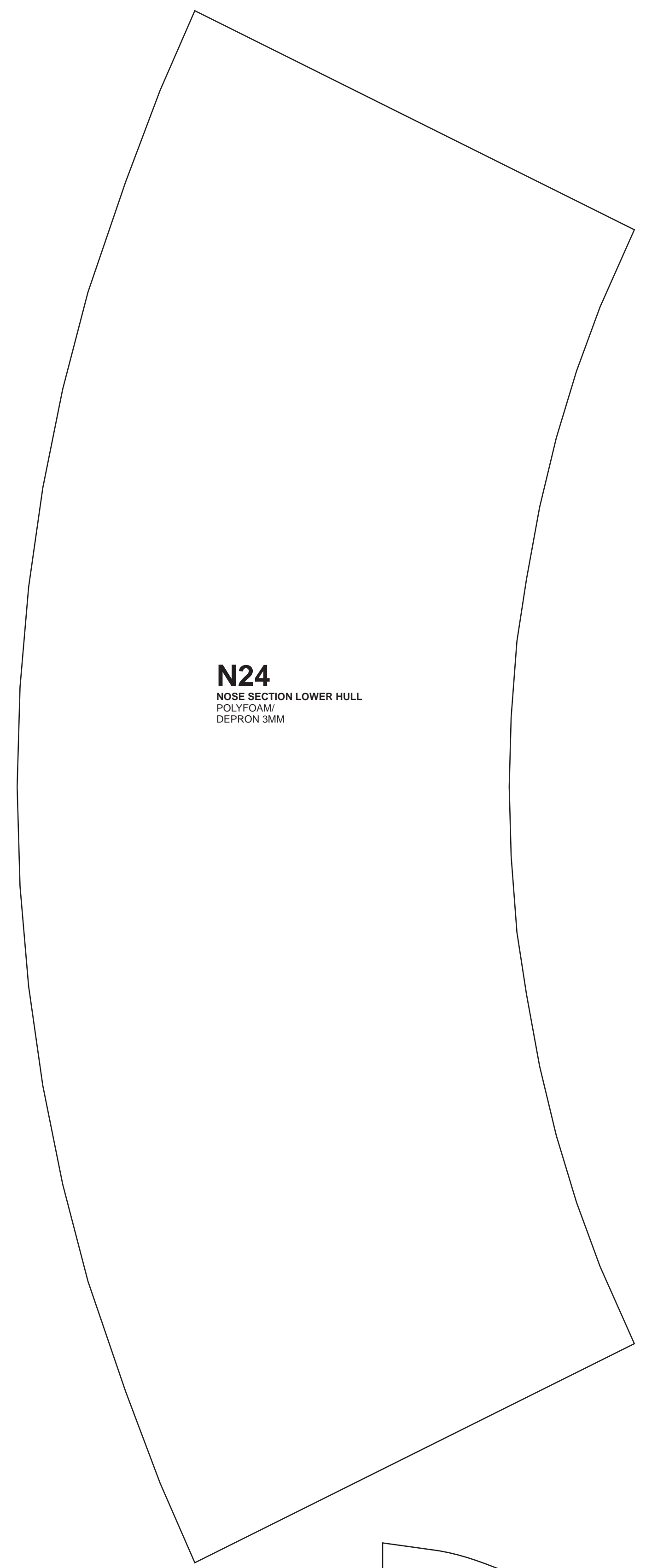

**N24**  
NOSE SECTION LOWER HULL  
POLYFOAM  
DEPRON 3MM

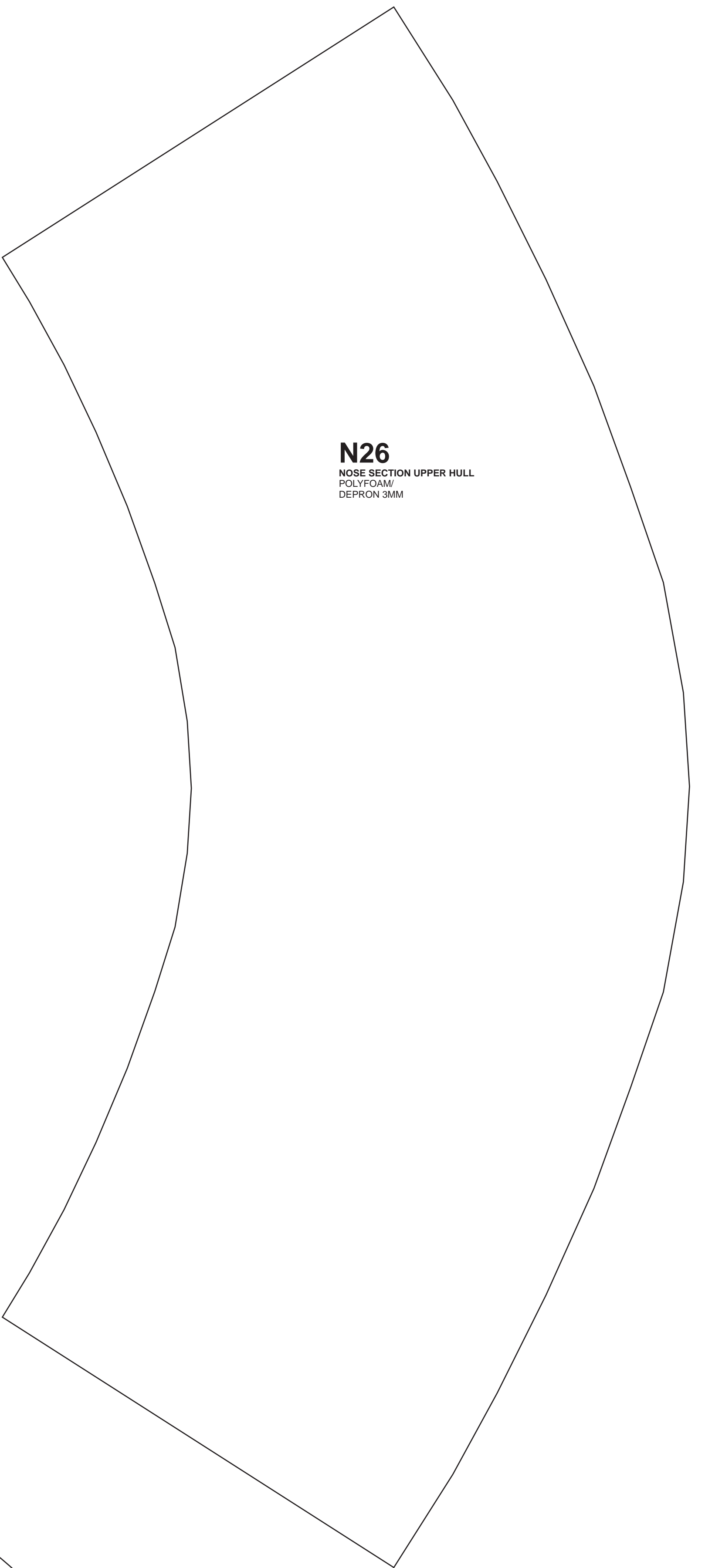

**N26**  
NOSE SECTION UPPER HULL  
POLYFOAM  
DEPRON 3MM

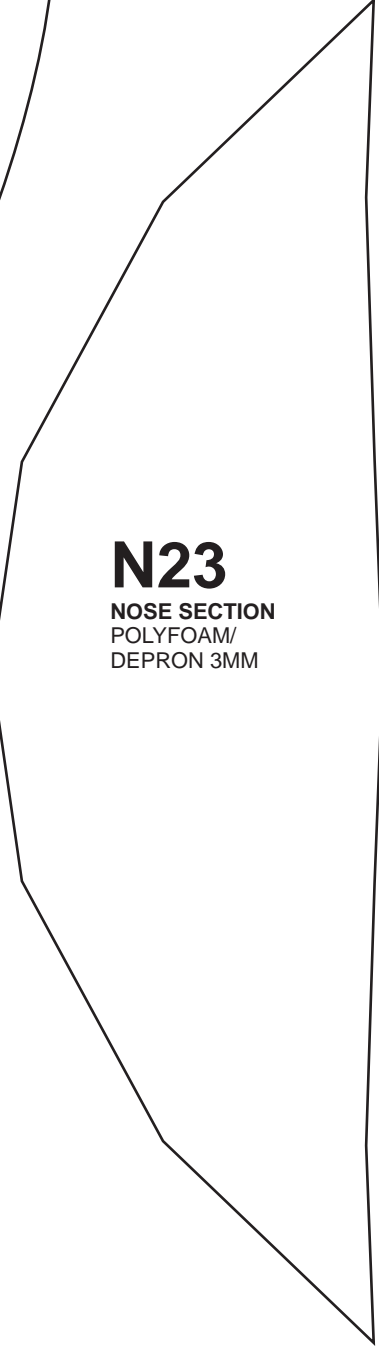

**N23**  
NOSE SECTION  
POLYFOAM  
DEPRON 3MM

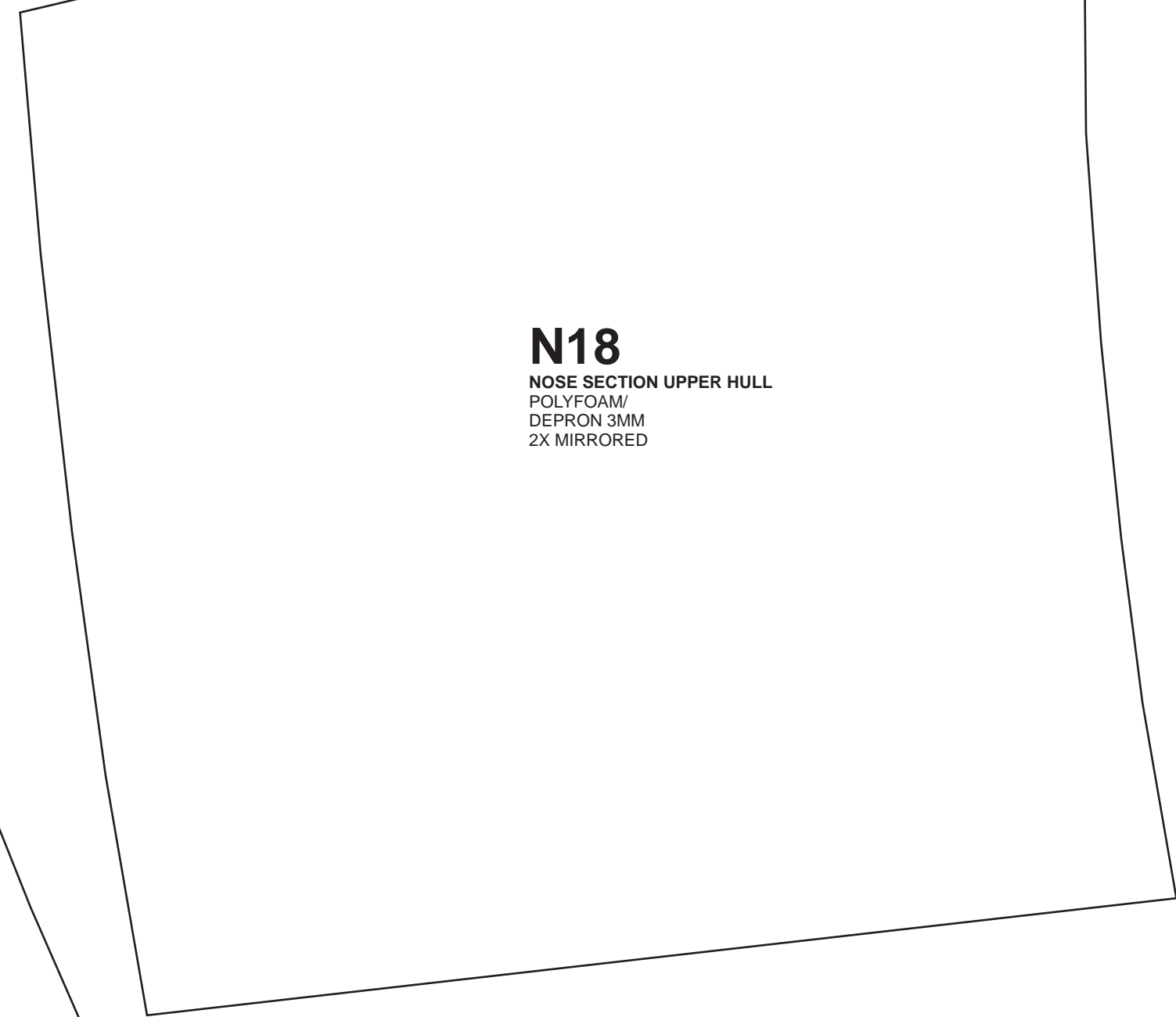

**N18**  
NOSE SECTION UPPER HULL  
POLYFOAM  
DEPRON 3MM  
2X MIRRORRED

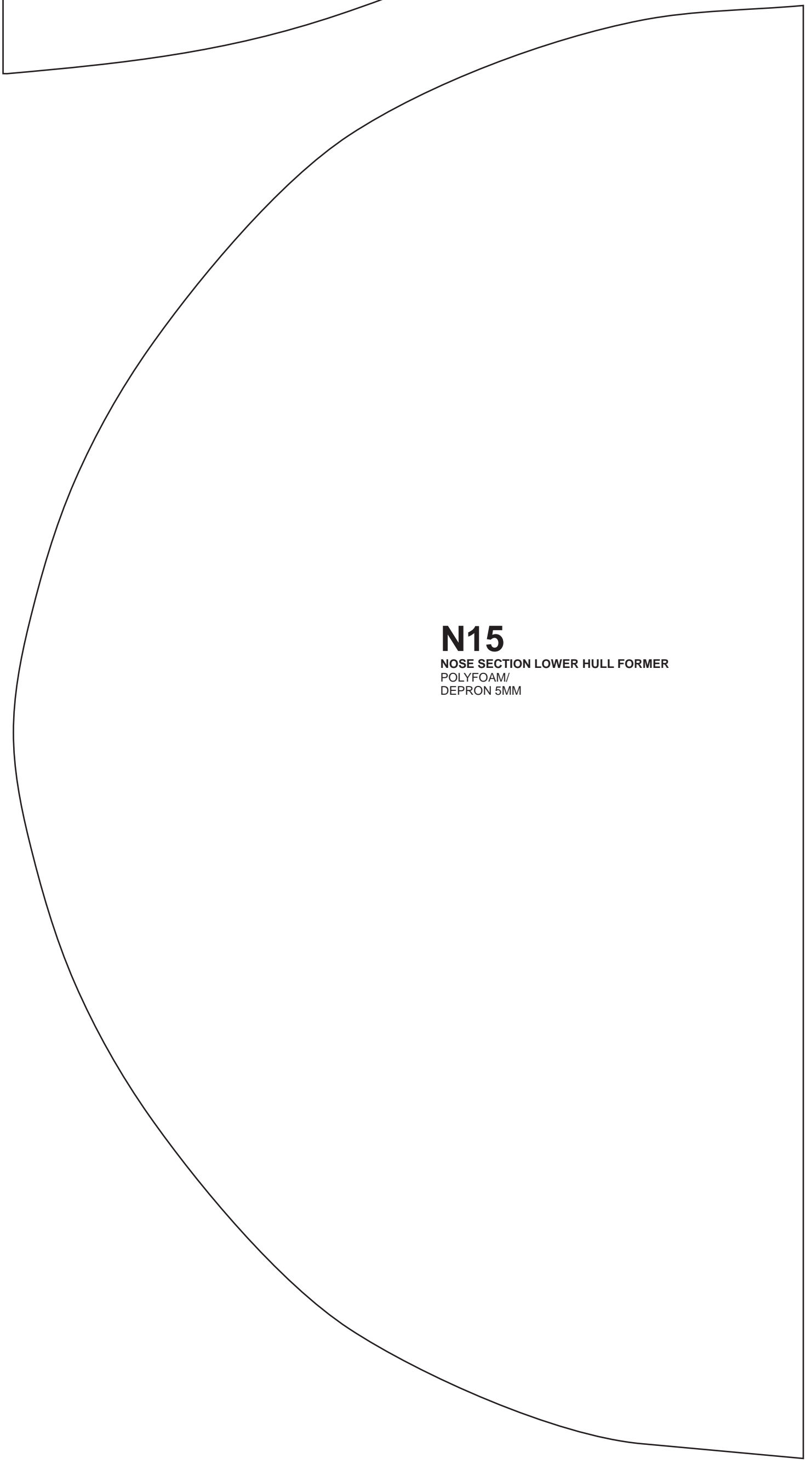

**N15**  
NOSE SECTION LOWER HULL FORMER  
POLYFOAM  
DEPRON 3MM

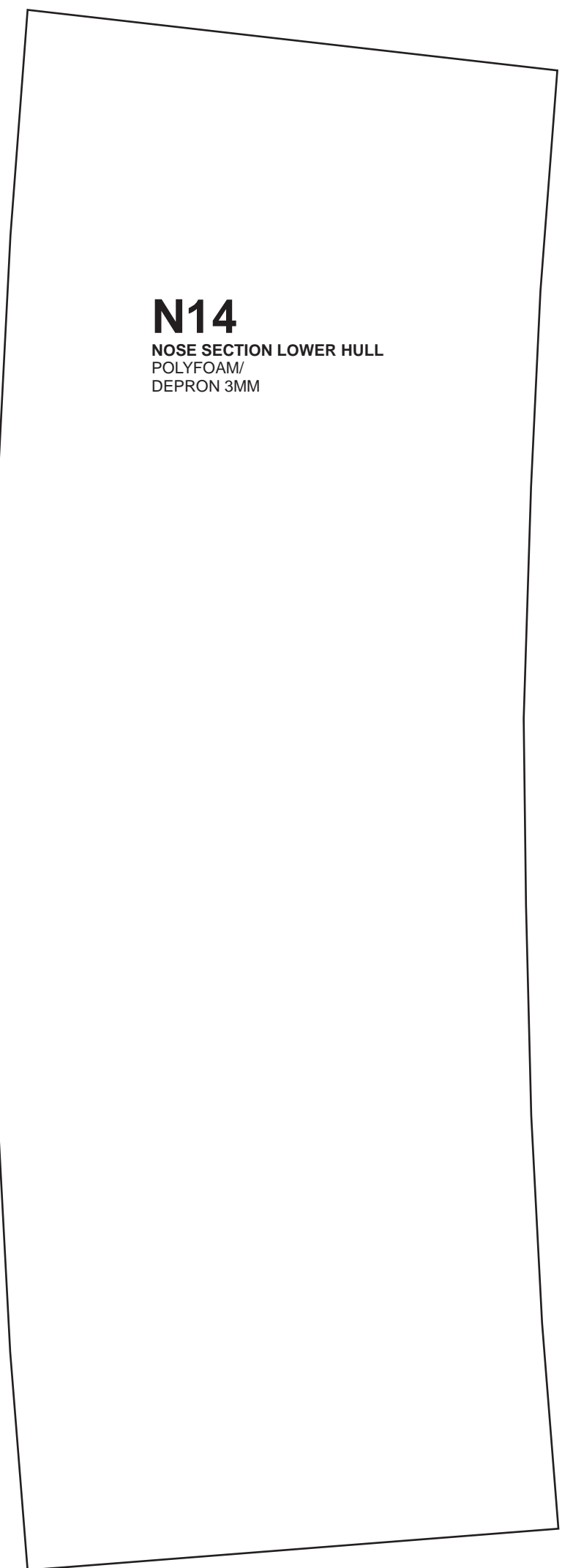

**N14**  
NOSE SECTION LOWER HULL  
POLYFOAM  
DEPRON 3MM

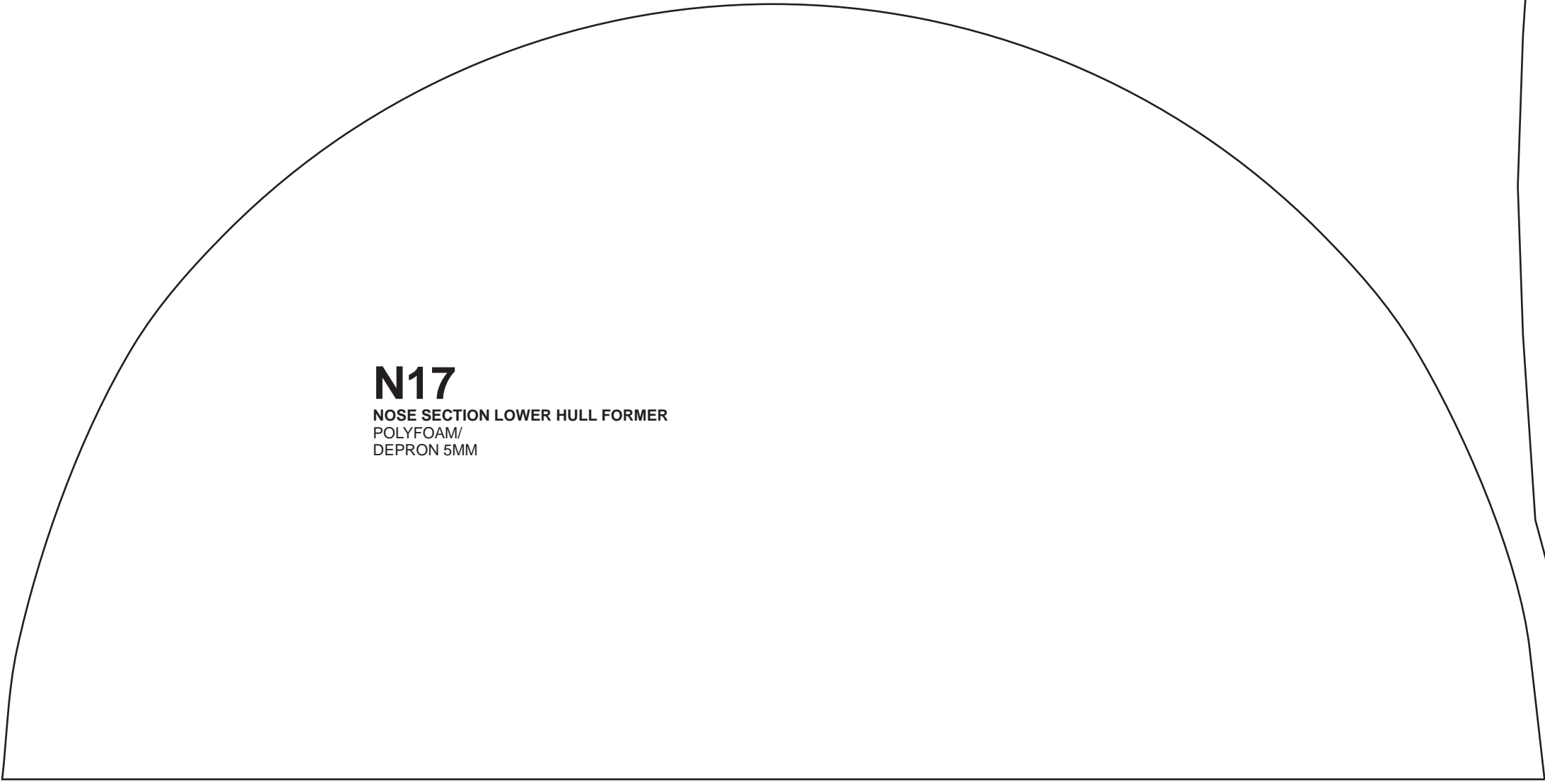

**N17**  
NOSE SECTION LOWER HULL FORMER  
POLYFOAM  
DEPRON 3MM

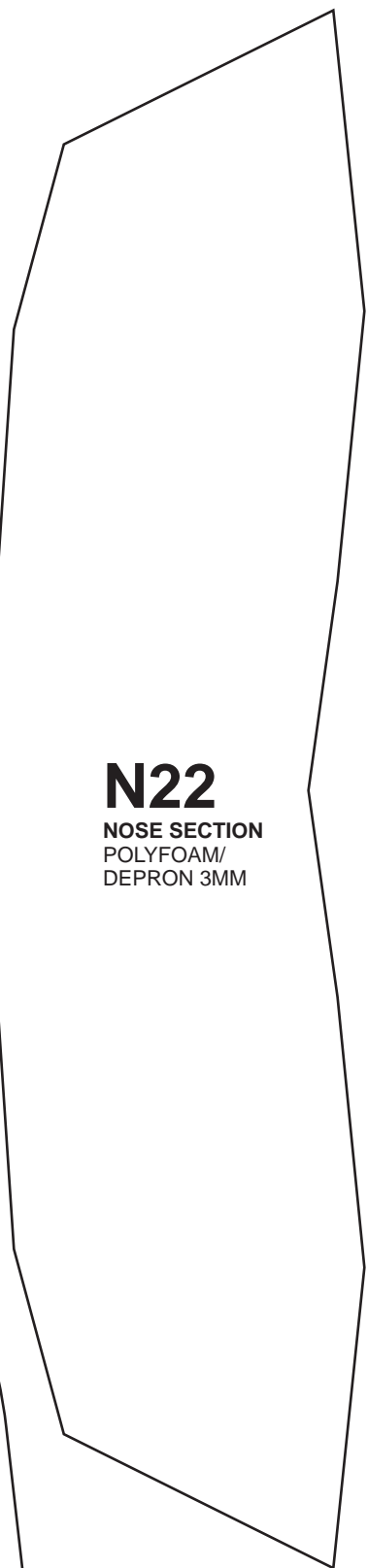

**N22**  
NOSE SECTION  
POLYFOAM  
DEPRON 3MM

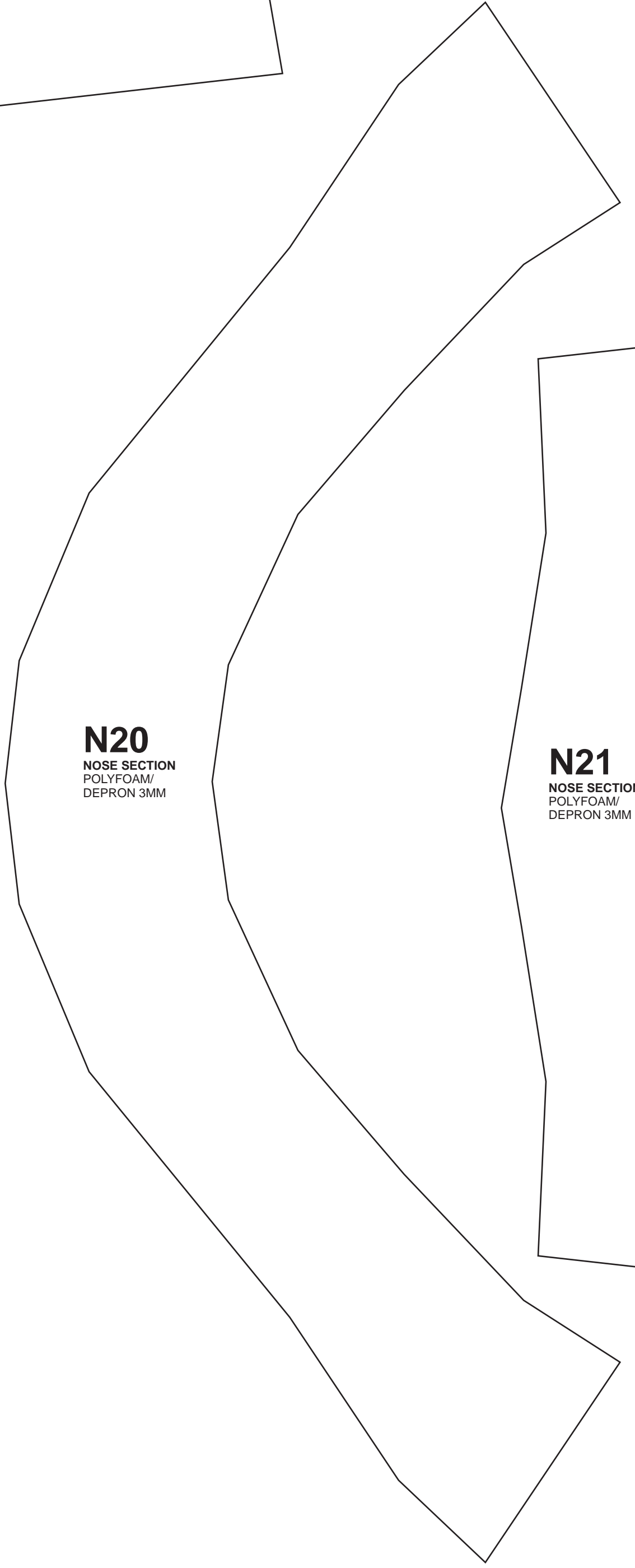

**N20**  
NOSE SECTION  
POLYFOAM  
DEPRON 3MM



**N21**  
NOSE SECTION  
POLYFOAM  
DEPRON 3MM

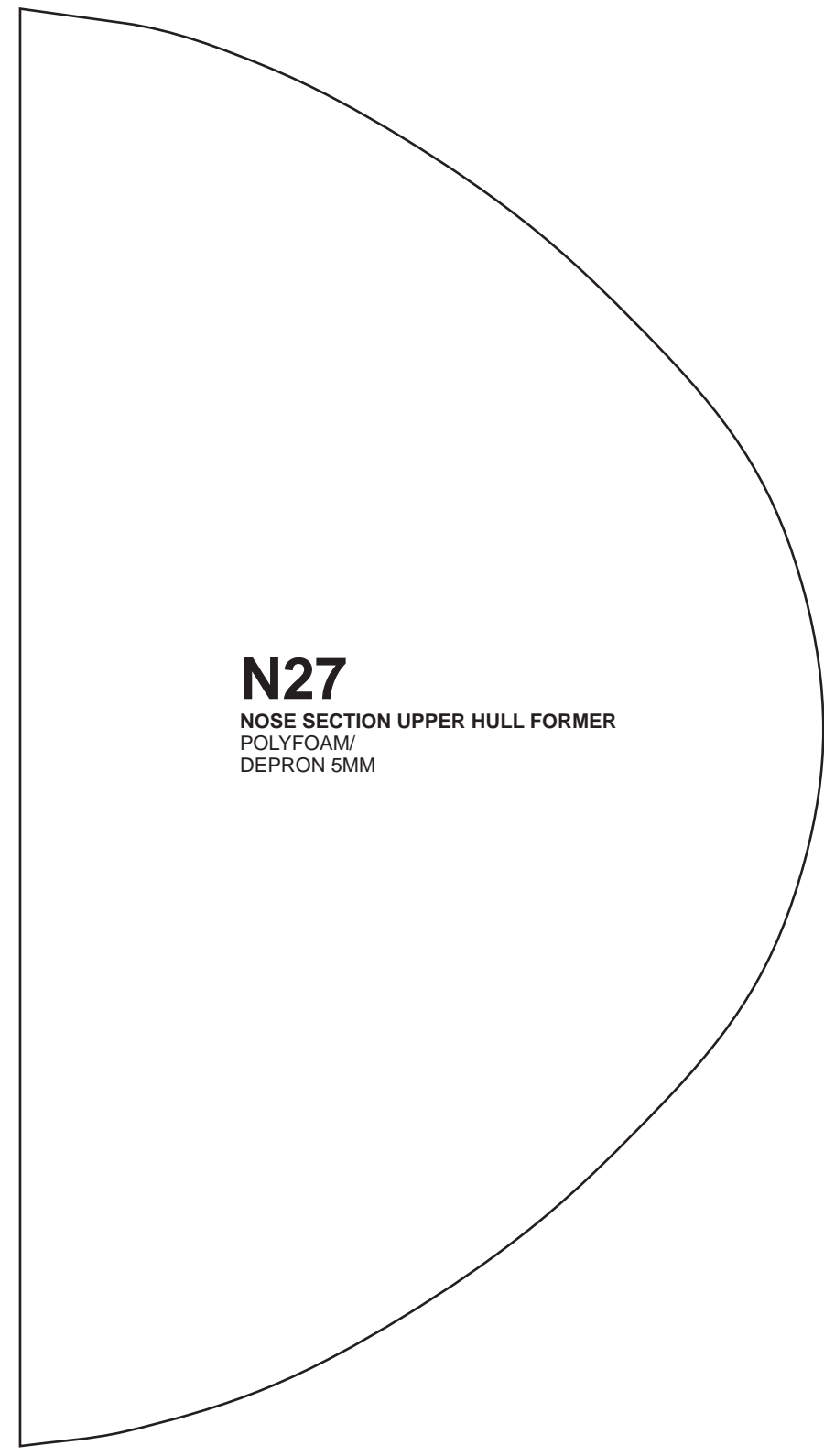

**N27**  
NOSE SECTION UPPER HULL FORMER  
POLYFOAM  
DEPRON 3MM

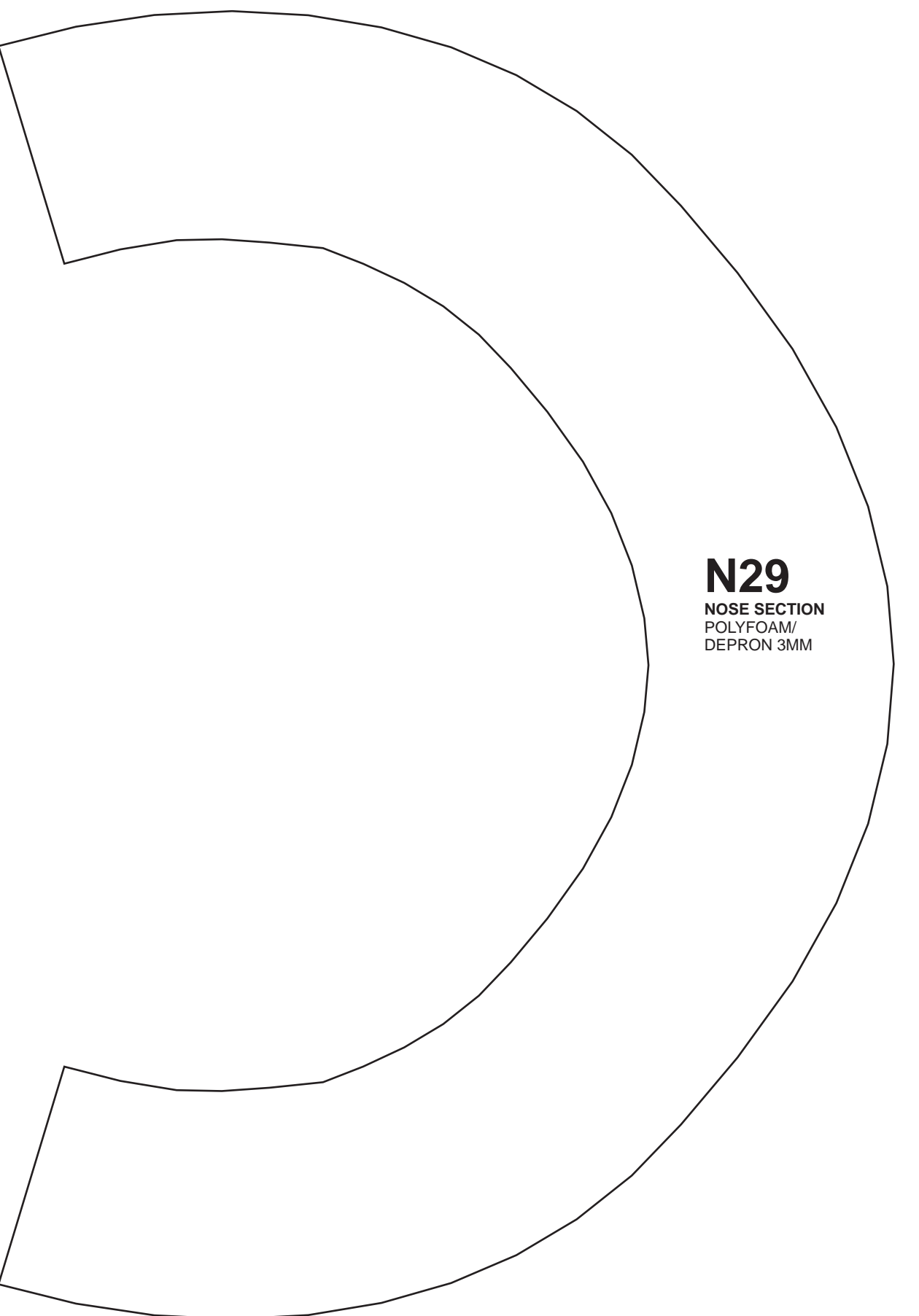

**N29**  
NOSE SECTION  
POLYFOAM  
DEPRON 3MM

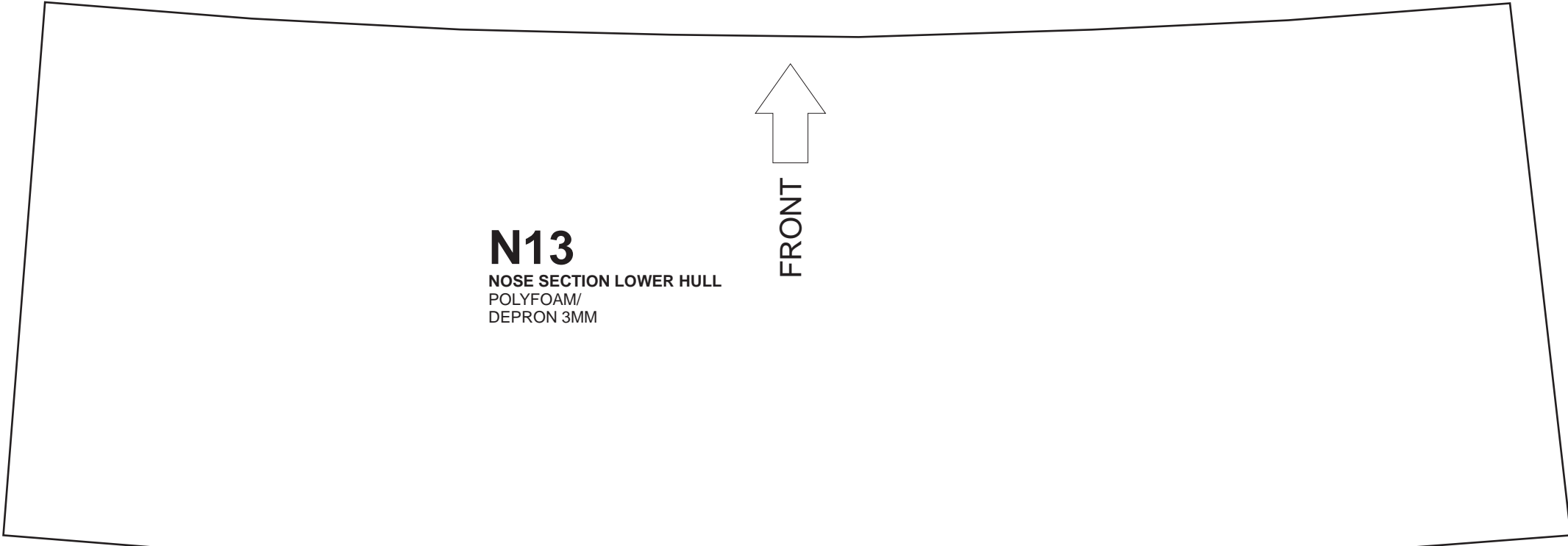

**N13**  
NOSE SECTION LOWER HULL  
POLYFOAM  
DEPRON 3MM

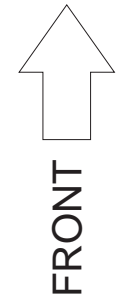



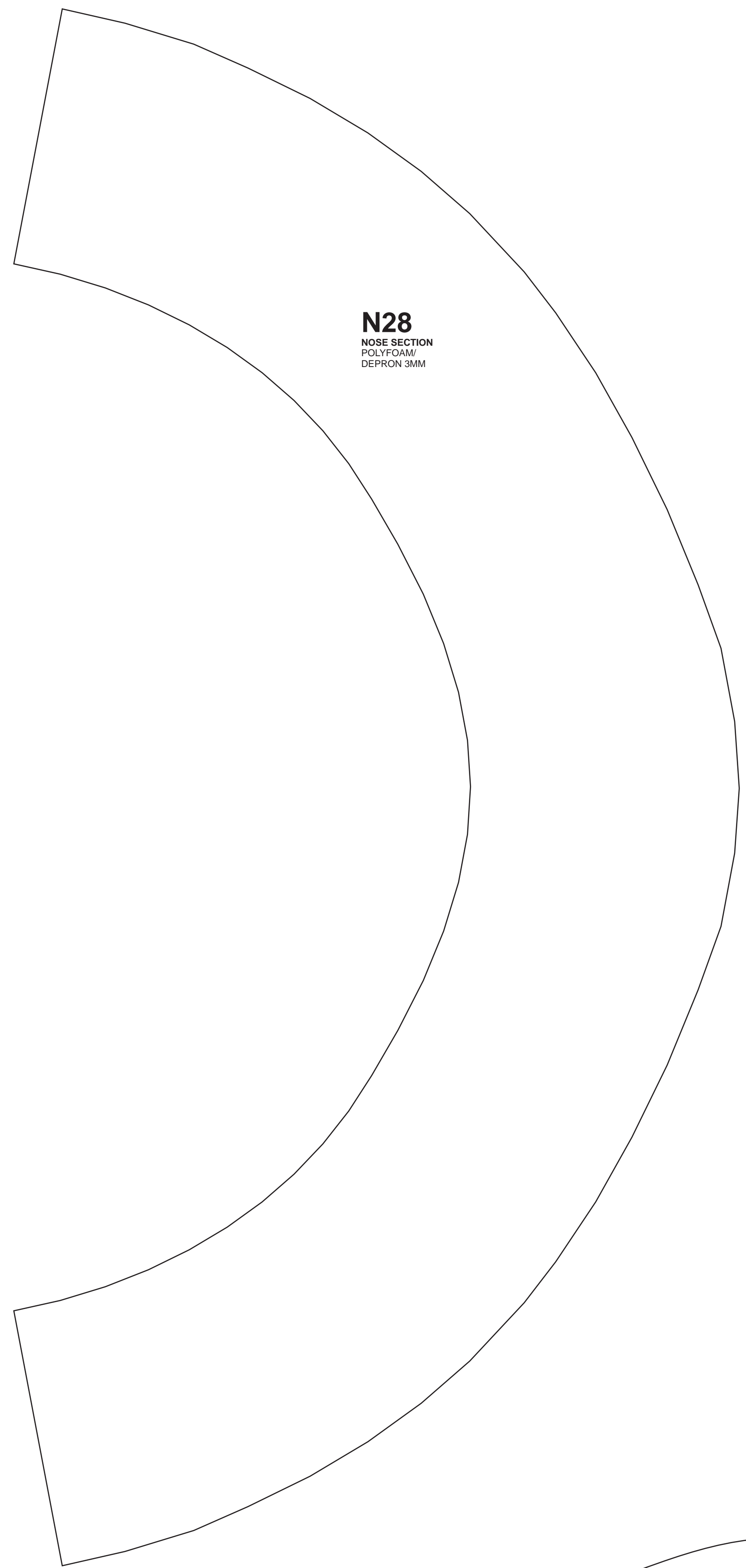

**N28**  
NOSE SECTION  
POLYFOAM  
DEPRON 3MM



**F3**  
FUSELAGE SECTION LOWER HULL FORMER  
POLYFOAM  
DEPRON 3MM  
FRONT FORMER

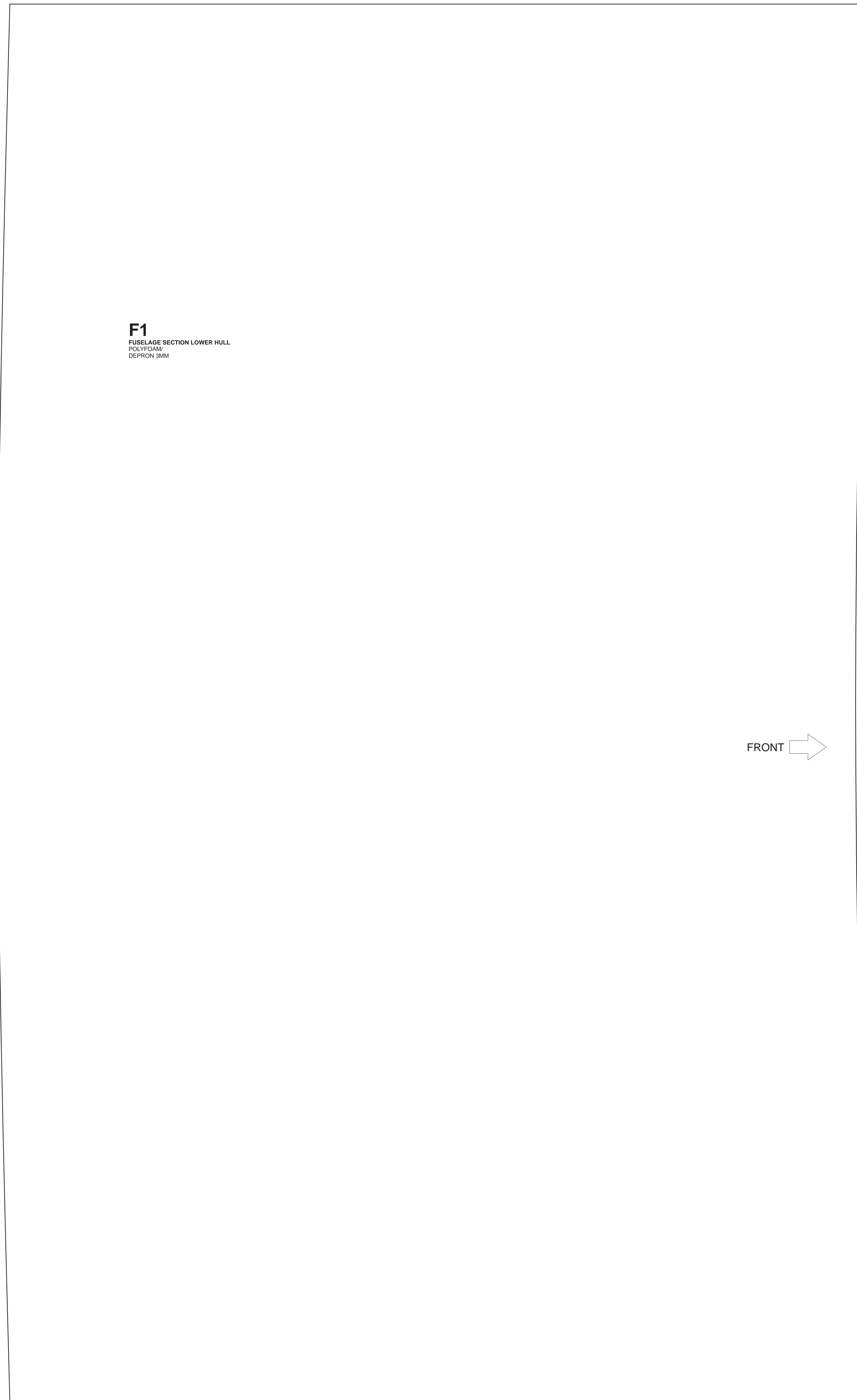

**F1**  
FUSELAGE SECTION LOWER HULL  
POLYFOAM  
DEPRON 3MM

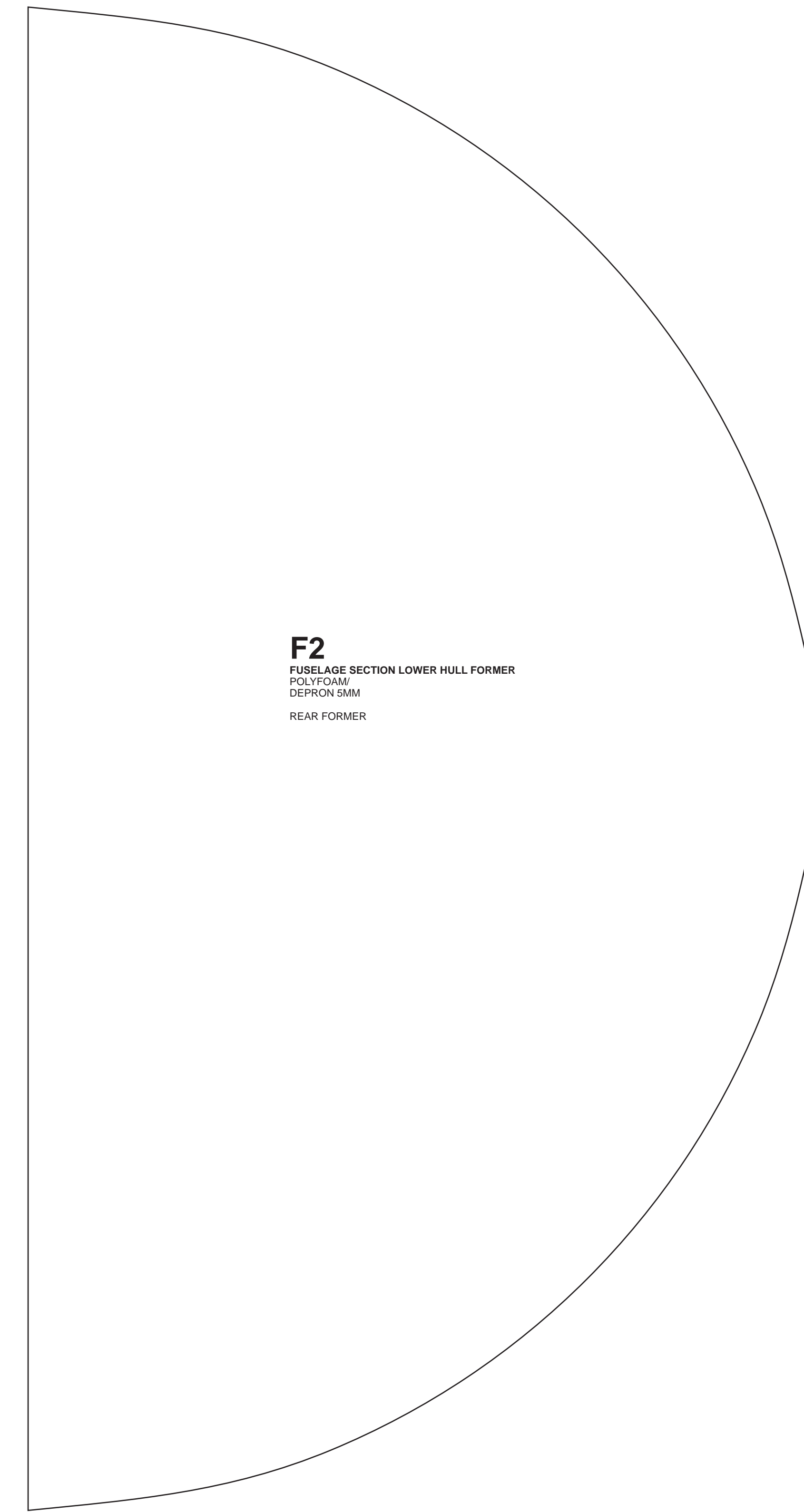

**F2**  
FUSELAGE SECTION LOWER HULL FORMER  
POLYFOAM  
DEPRON 3MM  
REAR FORMER

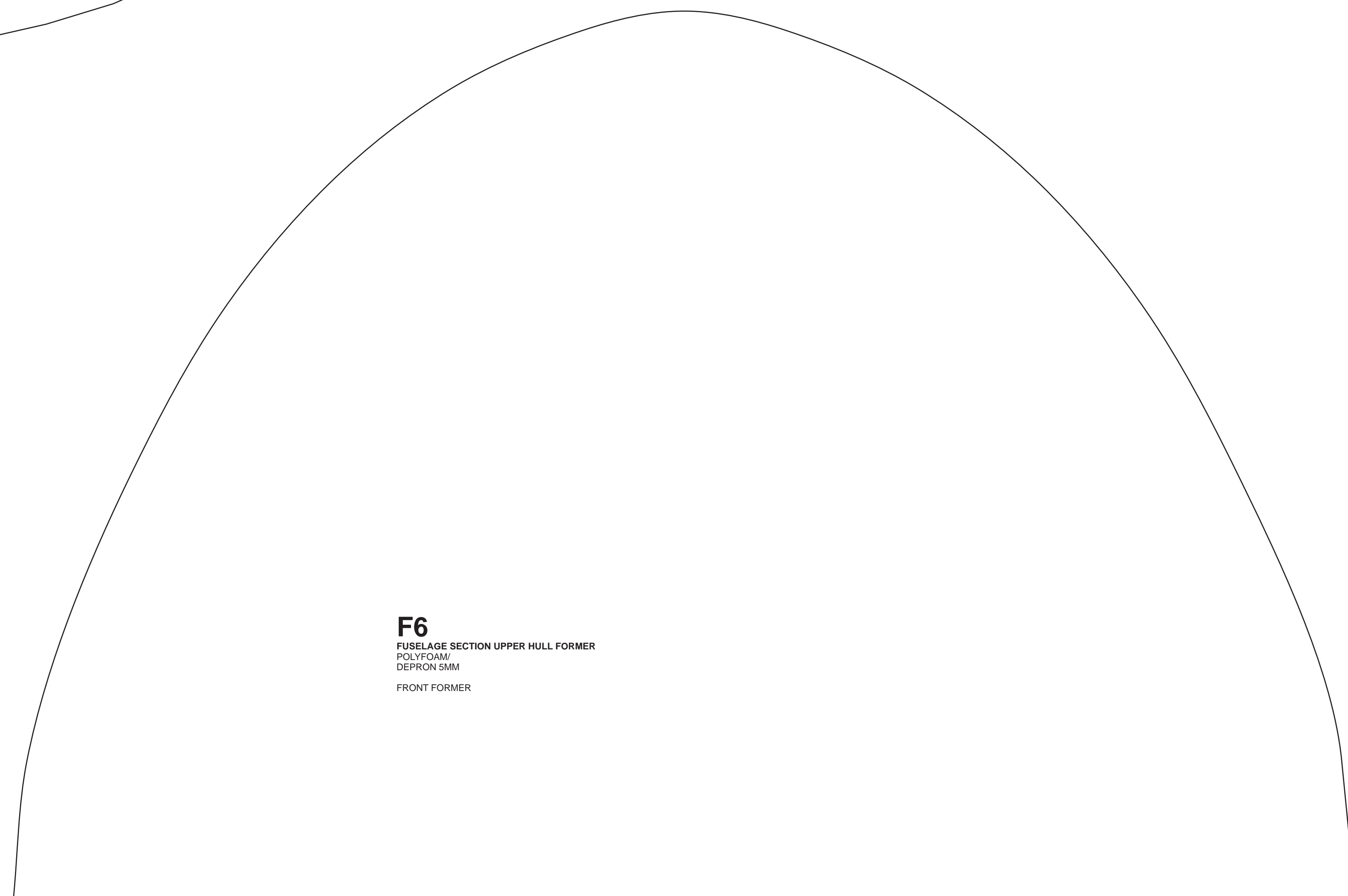

**F6**  
FUSELAGE SECTION UPPER HULL FORMER  
POLYFOAM  
DEPRON 3MM  
FRONT FORMER

FRONT 

**F4**

FUSELAGE SECTION UPPER HULL  
POLYFOAM  
DEPRON 3MM

**F5**

FUSELAGE SECTION UPPER HULL FORMER  
POLYFOAM  
DEPRON 3MM  
REAR FORMER