



Model : 07/2019



BOMBARDIER CL-415 MP

1800mm PART 1

Specs :

1. Wingspan 180 cm / 70.9 inches
2. Flying weight :
3. Wing loading :
4. Wing cube loading :
5. Wing Area

Electronics

- 2X Turnigy 2830 1000kv motor
- 2X ESC 40A
- 1X / 2X Battery Lipo 3S 2200mah / Li-ion 3S 3300 mah / Lipo 3S 5200mah
- 7 X 9 gram servos
- Propeller : 8x6x4

Materials :

1. 5mm Depron/ Polyfoam
2. 3mm Plywood
3. 2.5 mm bicycle wheel spokes
4. 0.3 mm mica plastic
5. 2 pcs ice cream sticks
6. White packing tape
7. Eva foam
8. 62 mm wheels
9. 40 mm wheels
10. Oracal stickers



Build Instructions :

1. paper-replika.com
2. youtube channel : Julius Perdana

JOIN HERE

F2

F4

LANDING GEAR PLATE
POLYFOAM/ DEPRON 5MM

F5

LANDING GEAR PLATE
POLYFOAM/ DEPRON 5MM

F1

FUSELAGE WALL
POLYFOAM/ DEPRON 5MM
2X MIRRORED



Watch
Video Tutorial
for more detail
instructions



JOIN HERE

JOIN HERE



F1

JOIN HERE

F2



Watch
Video Tutorial
for more detail
instructions

F2

FRONT HULL
POLYFOAM/ DEPRON 5MM
2X MIRRORED

JOIN HERE

JOIN HERE

F3

FUSELAGE FORMER
POLYFOAM/ DEPRON 5MM

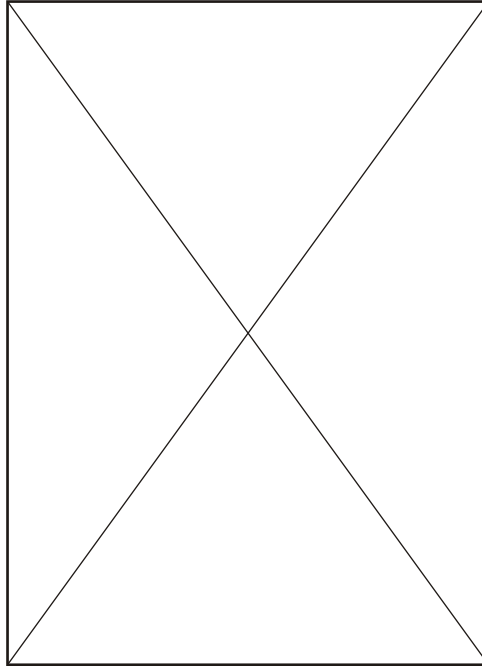

F6

LANDING GEAR PLATE
POLYFOAM/ DEPRON 5MM

F7

LANDING GEAR PLATE
POLYFOAM/ DEPRON 5MM
2X

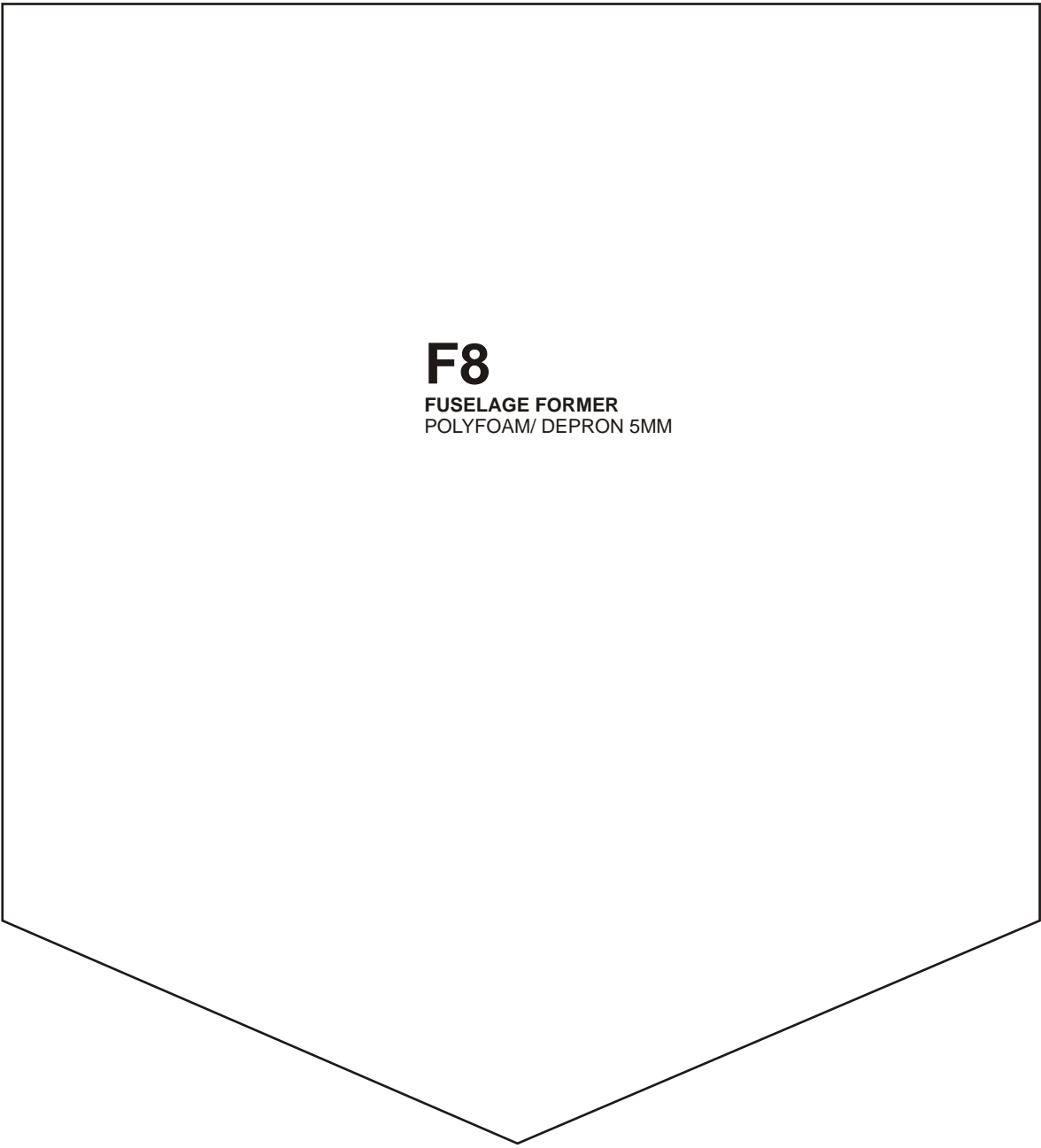

F8
FUSELAGE FORMER
POLYFOAM/ DEPRON 5MM

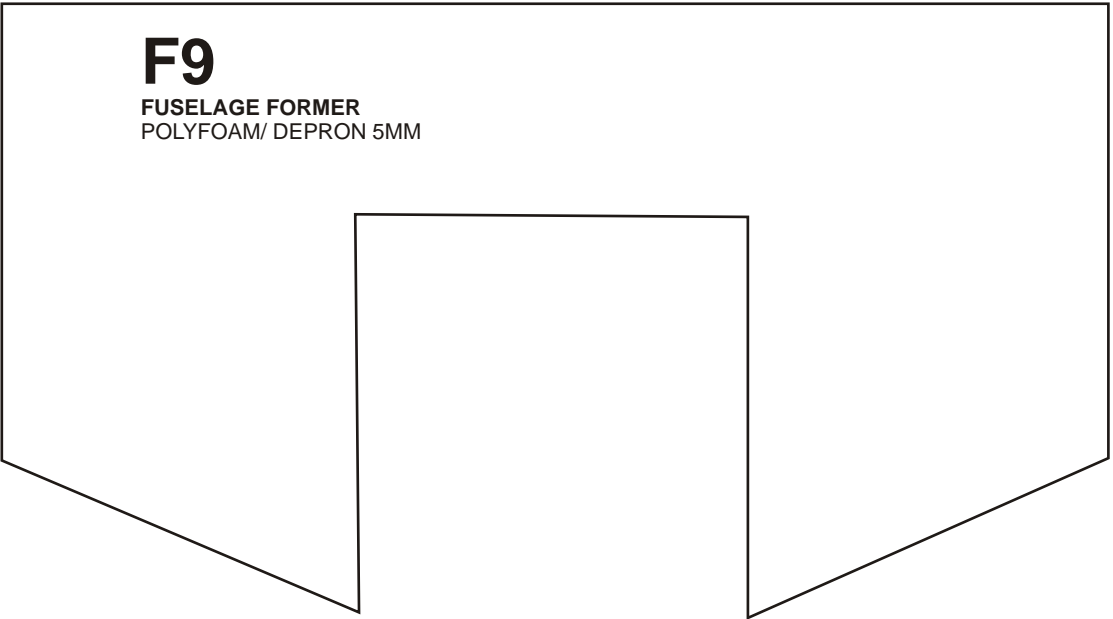

F9
FUSELAGE FORMER
POLYFOAM/ DEPRON 5MM

F10

FUSELAGE FORMER
POLYFOAM/ DEPRON 5MM

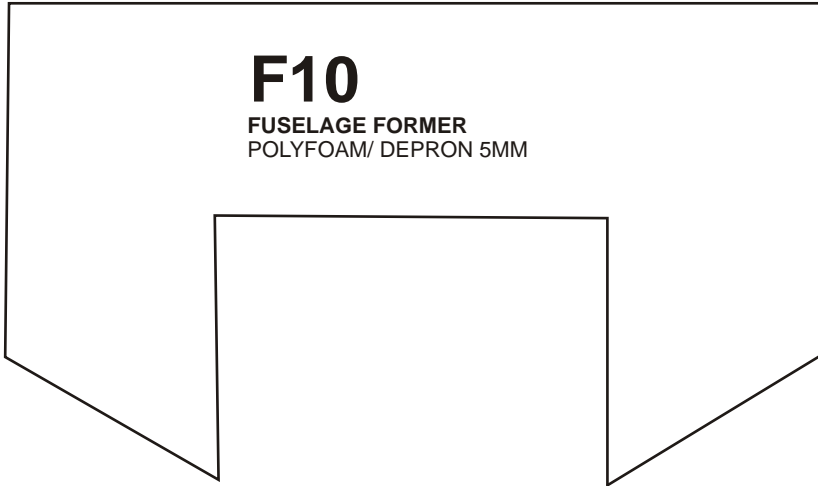

F11

FUSELAGE
POLYFOAM/ DEPRON 5MM





F12

COCKPIT
POLYFOAM/ DEPRON 5MM

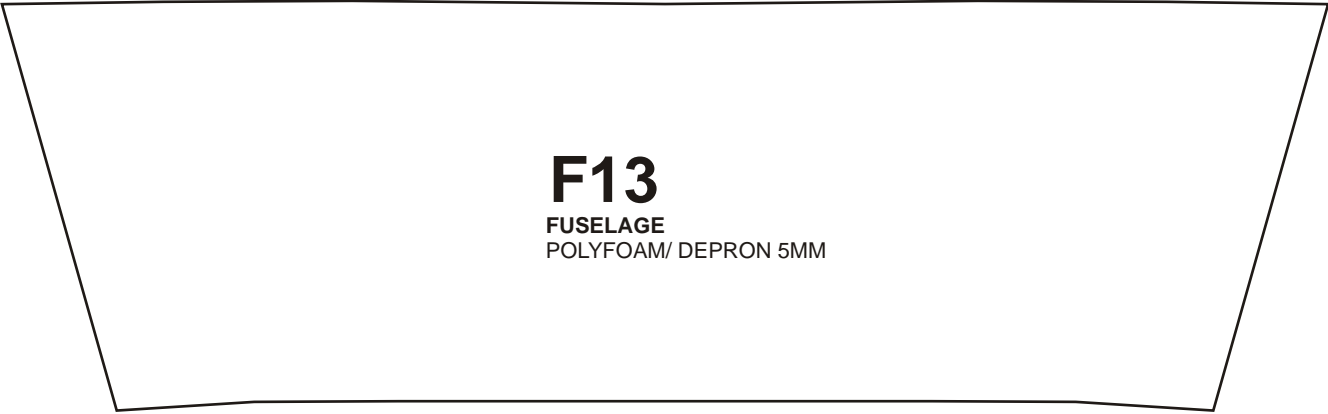

F13

FUSELAGE
POLYFOAM/ DEPRON 5MM

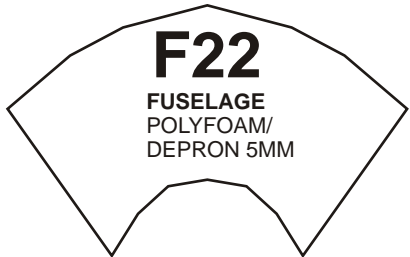
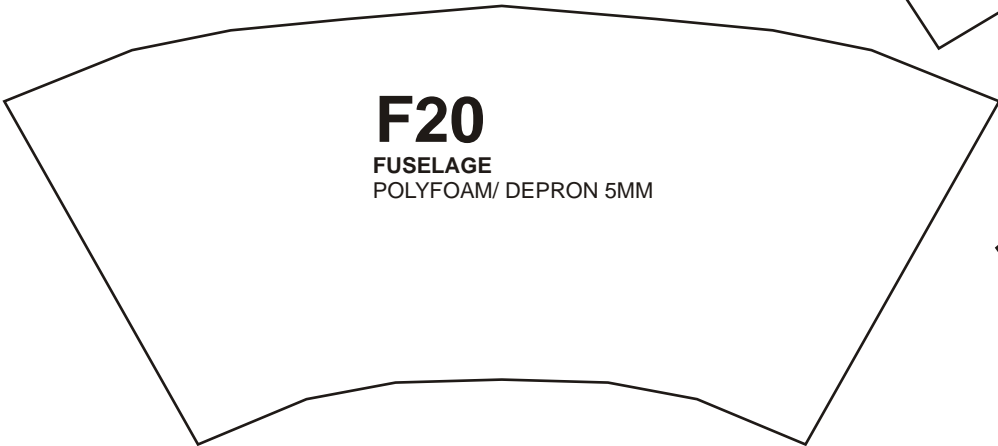
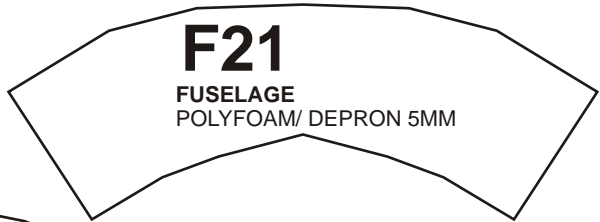
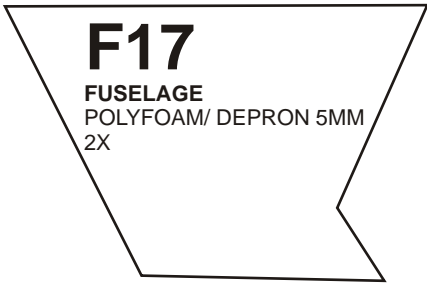
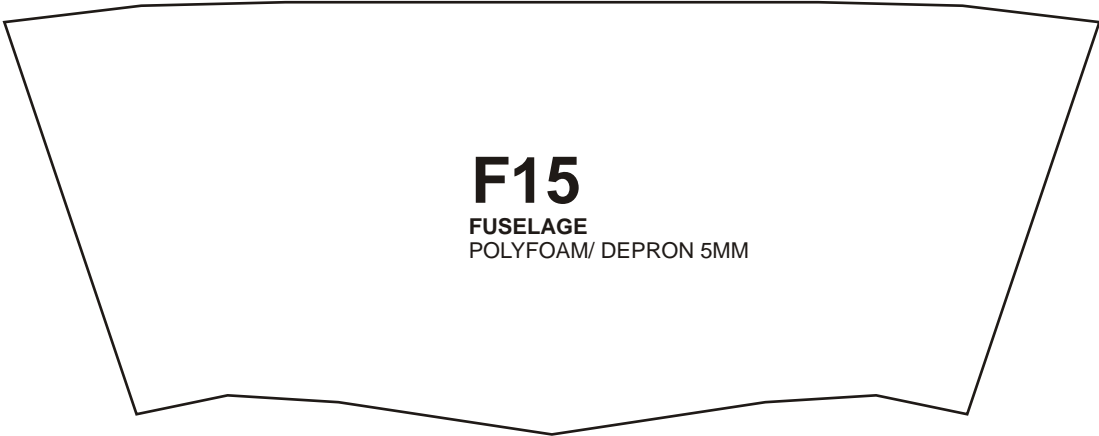
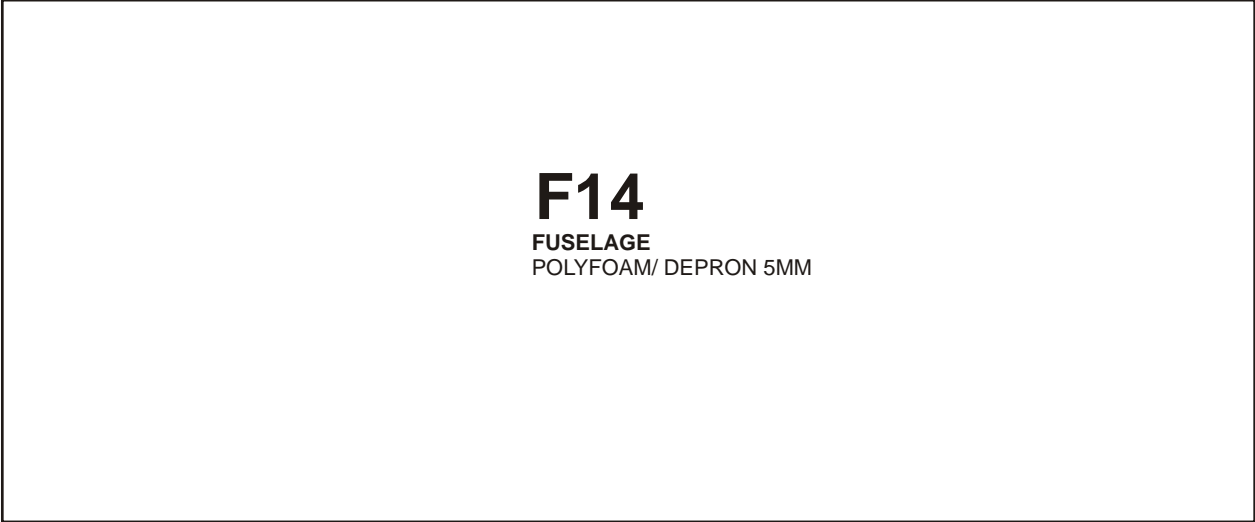

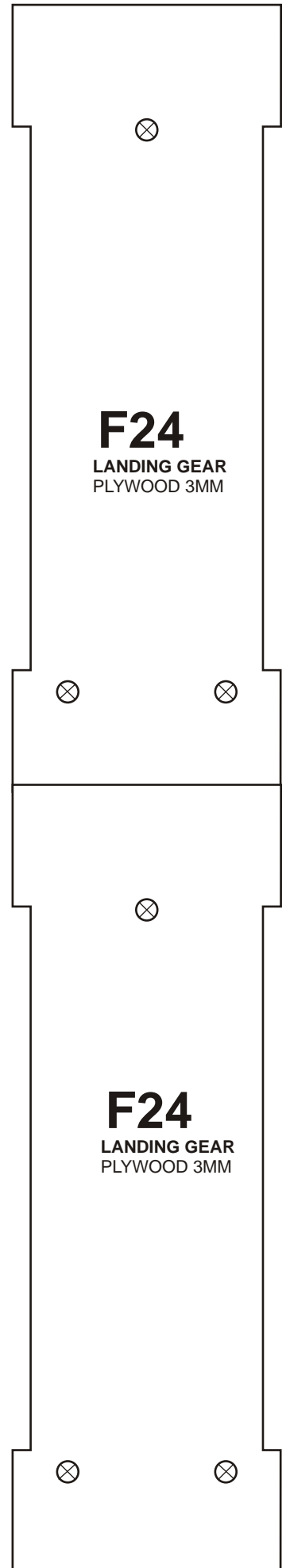
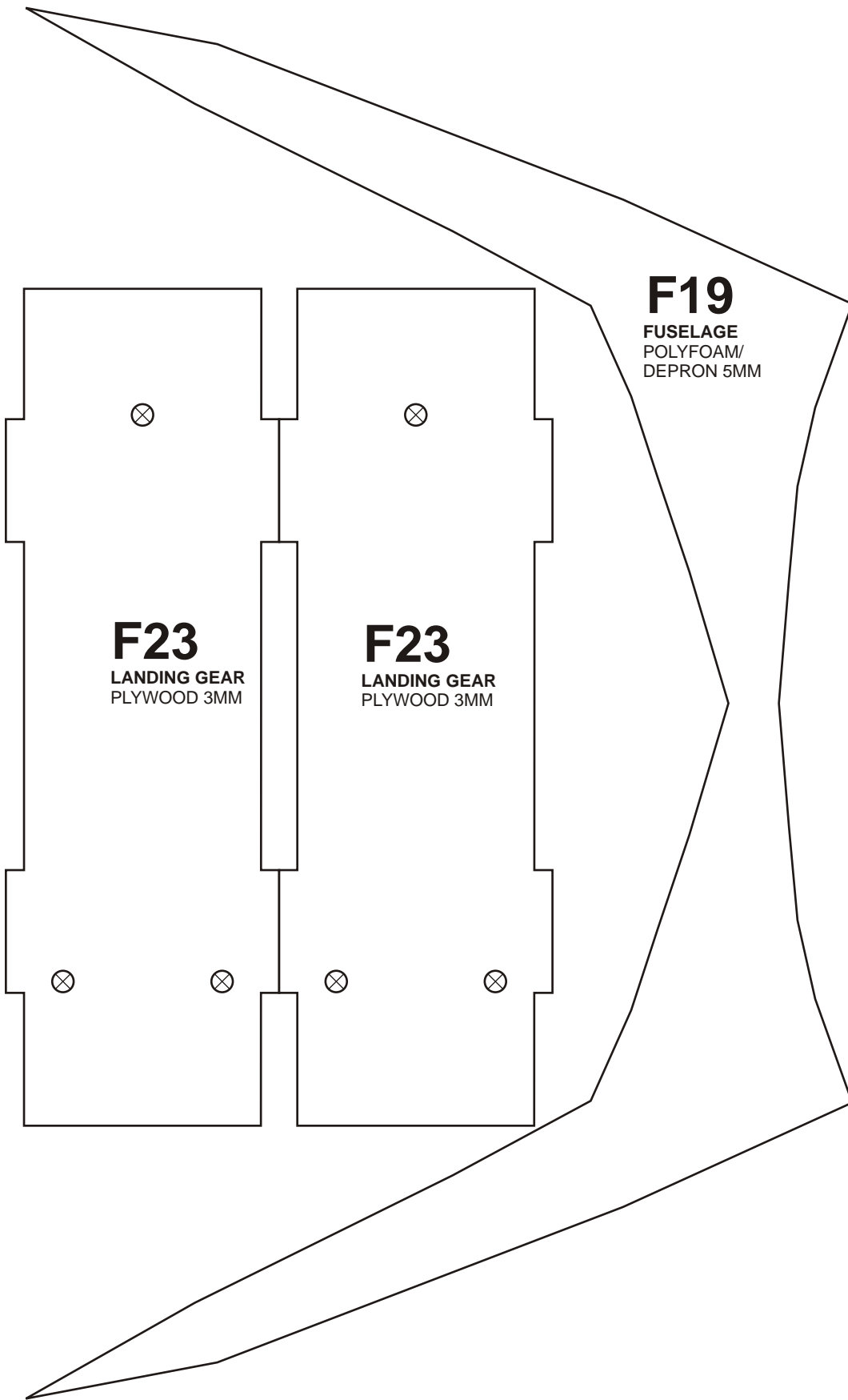

 Watch
Video Tutorial
for more detail
instructions

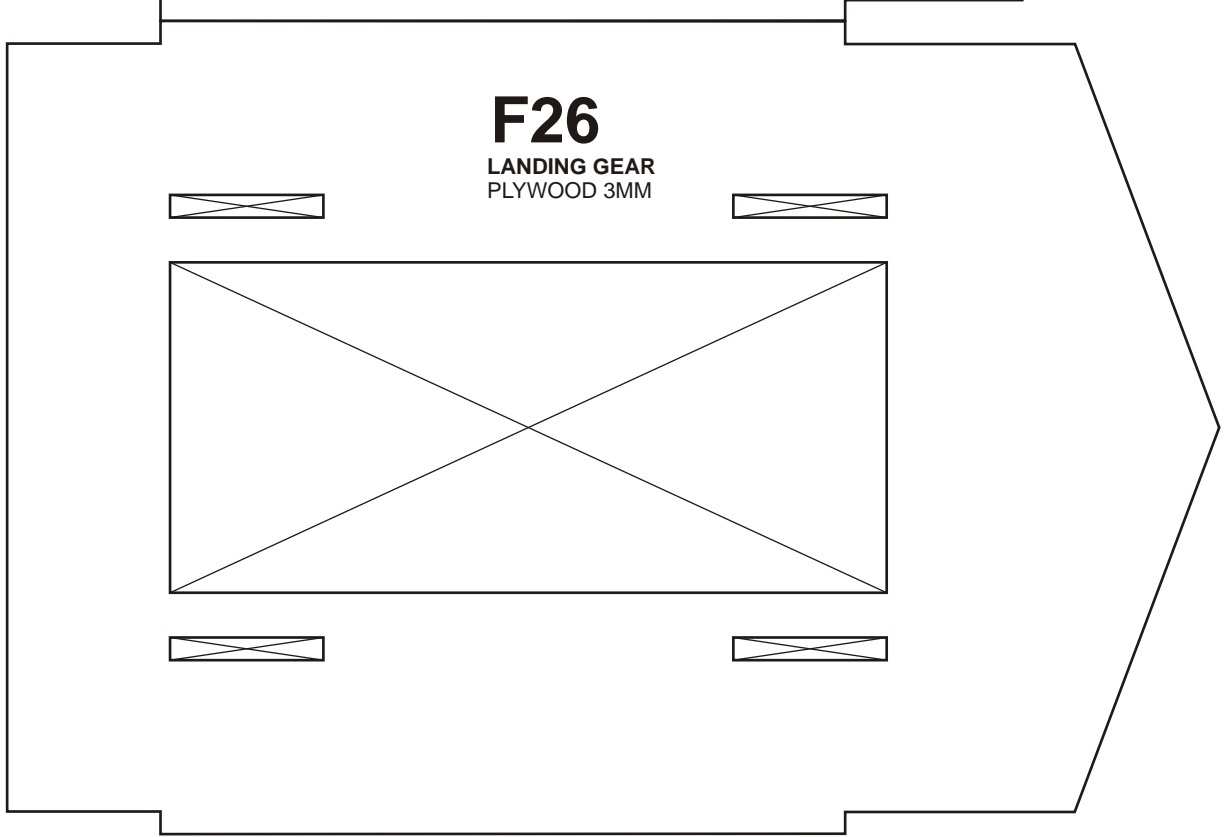
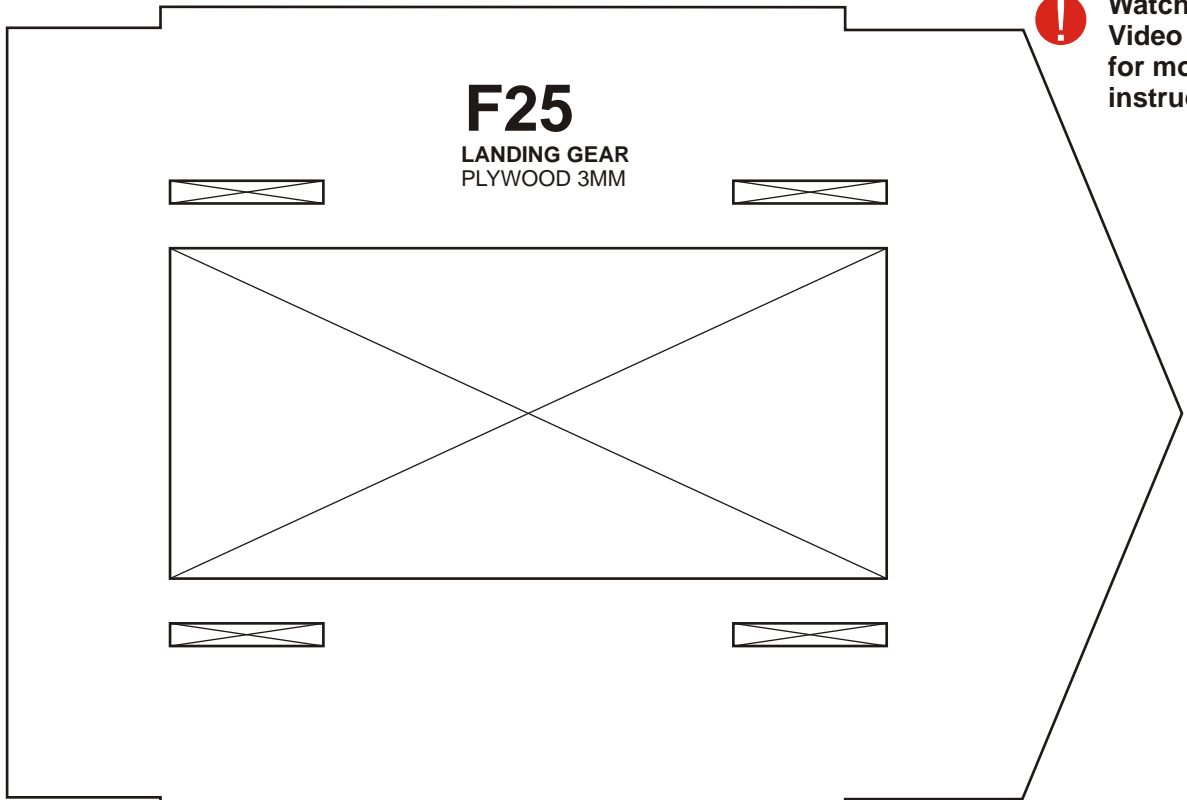

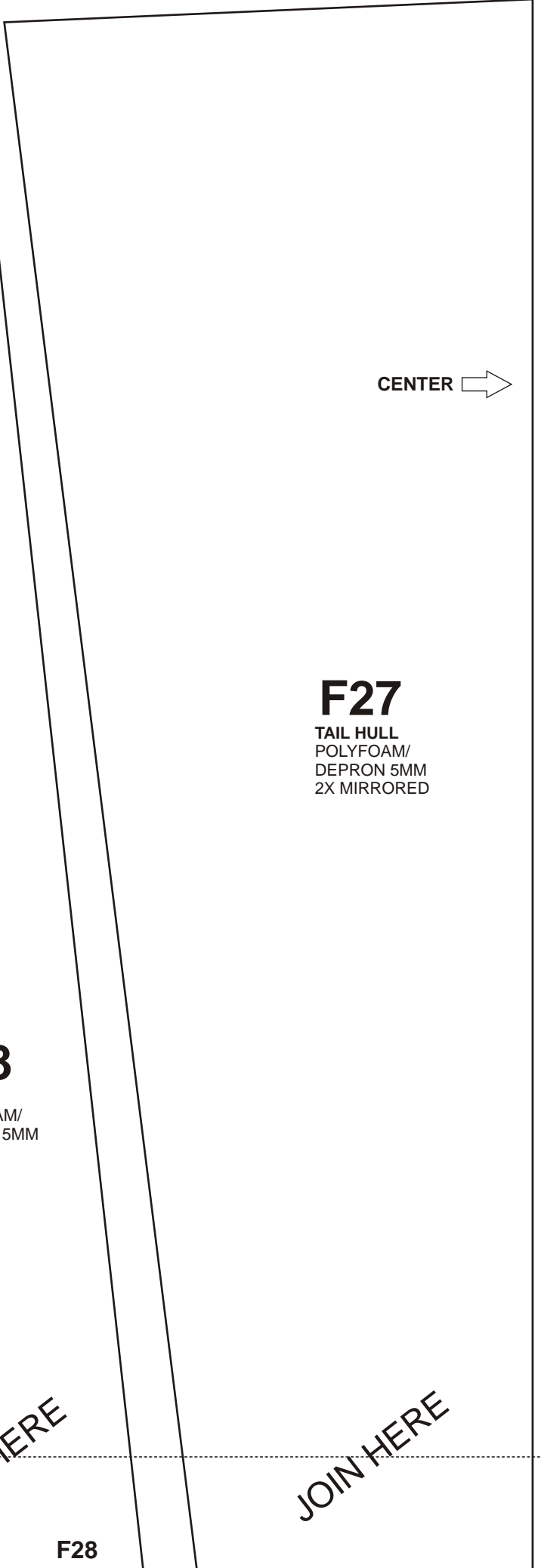
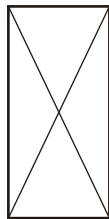
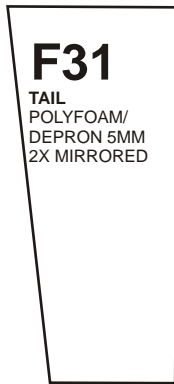
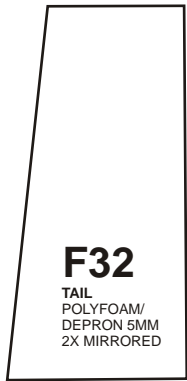
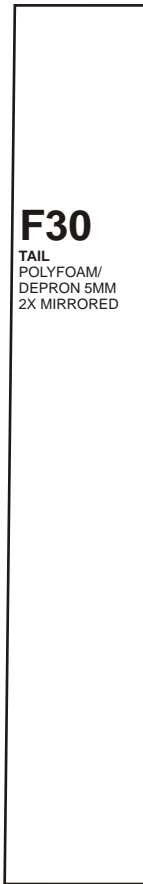

CENTER →



 **Watch
Video Tutorial
for more detail
instructions**

JOIN HERE

JOIN HERE

F28

JOIN HERE

F28

JOIN HERE

F27

JOIN HERE

F28

JOIN HERE

F27

JOIN HERE

F28

JOIN HERE

F27

F33

TAIL FORMER
POLYFOAM/
DEPRON 5MM

G2

LANDING GEAR
POLYFOAM/ DEPRON 5MM
8X

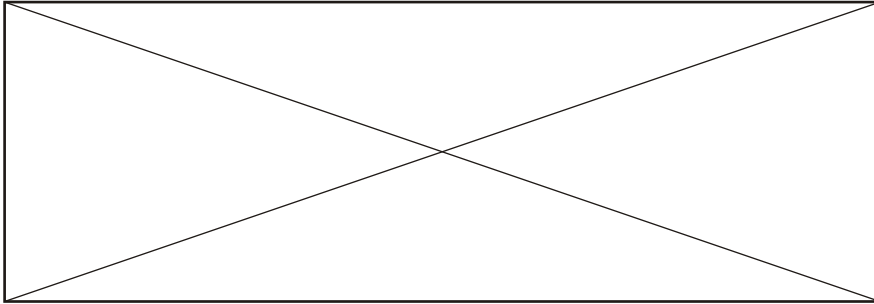

F34

TAIL WALL
POLYFOAM/ DEPRON 5MM
2X MIRRORED



Watch
Video Tutorial
for more detail
instructions

JOIN HERE

G3

FUSELAGE
POLYFOAM/ DEPRON 5MM

JOIN HERE

F34

JOIN HERE

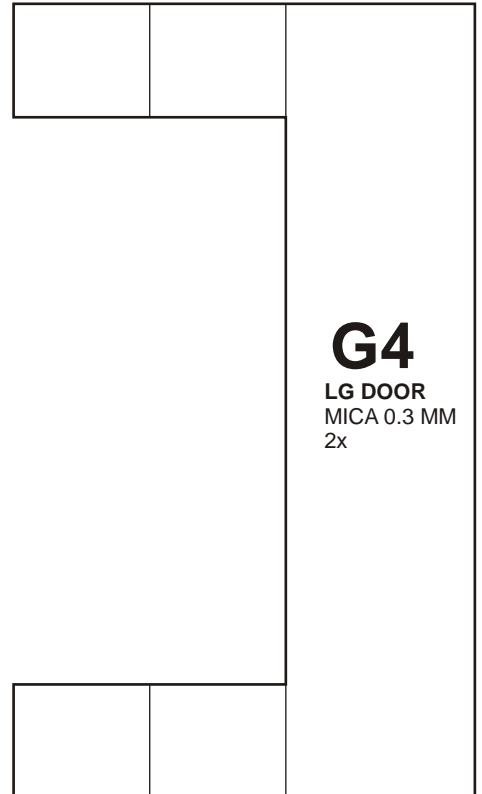

G4

LG DOOR
MICA 0.3 MM
2x

JOIN HERE

F34



Watch
Video Tutorial
for more detail
instructions

F36
WINDSHIELD
MICA 0.3 MM

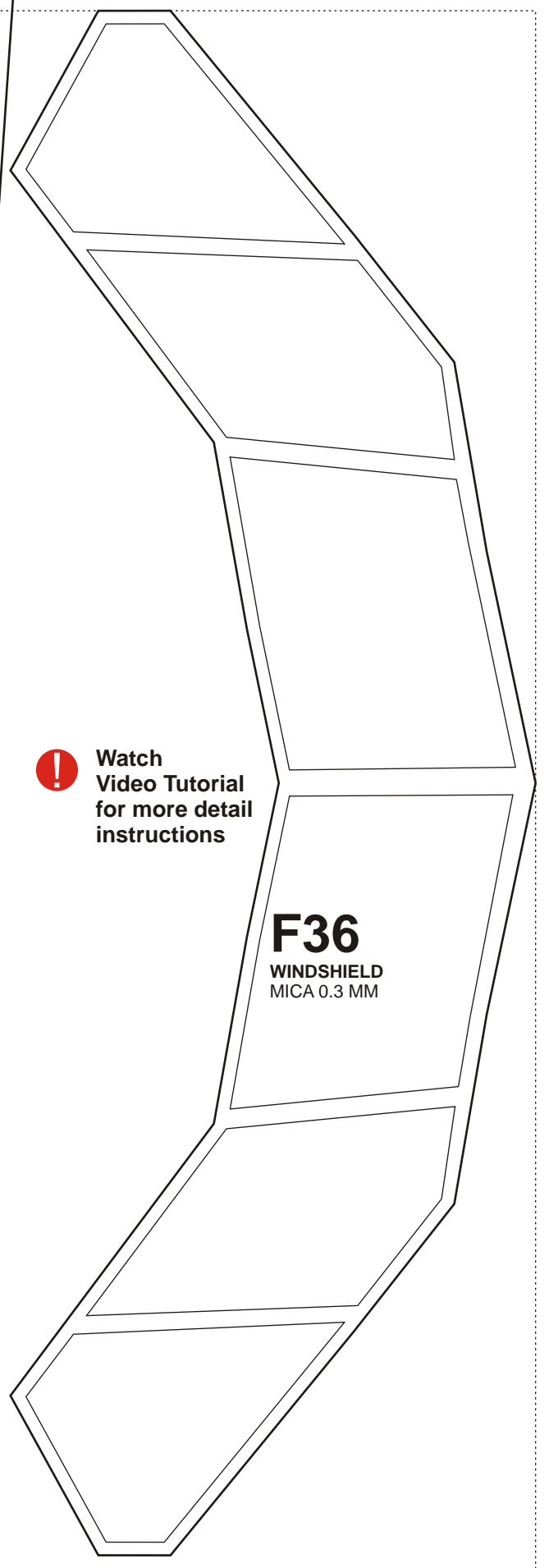

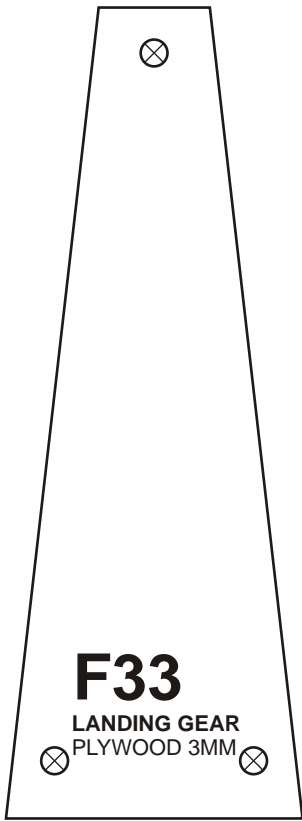

! Watch Video Tutorial for more detail instructions

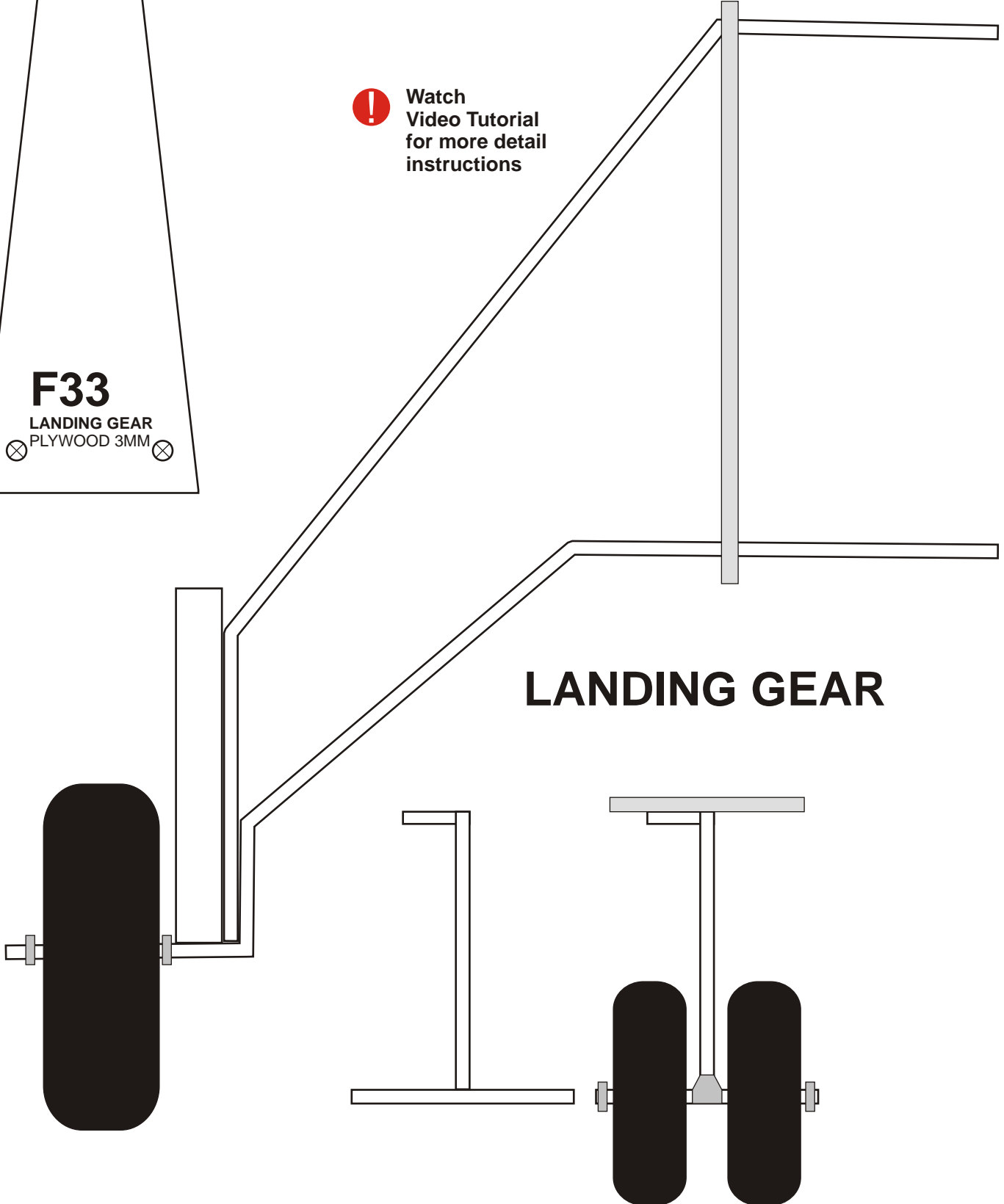

S1

VERTICAL STAB
POLYFOAM/ DEPRON 5MM
2X MIRRORED

JOIN HERE

JOIN HERE

S3

JOIN HERE

S2

JOIN HERE

DE

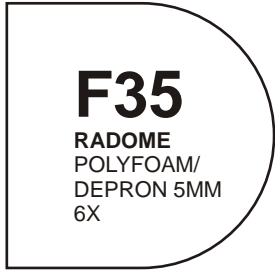

F35

RADOME
POLYFOAM/
DEPRON 5MM
6X

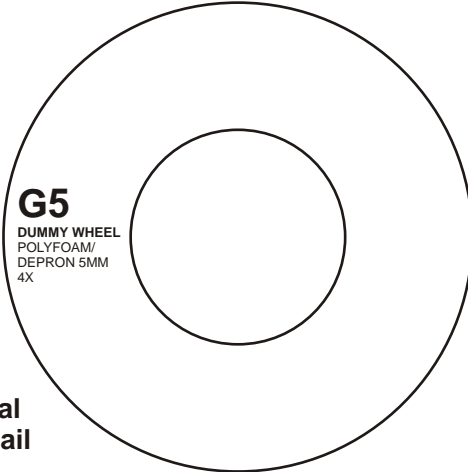

G5

DUMMY WHEEL
POLYFOAM/
DEPRON 5MM
4X



G7

DUMMY WHEEL
MICA
2X



**Watch
Video Tutorial
for more detail
instructions**

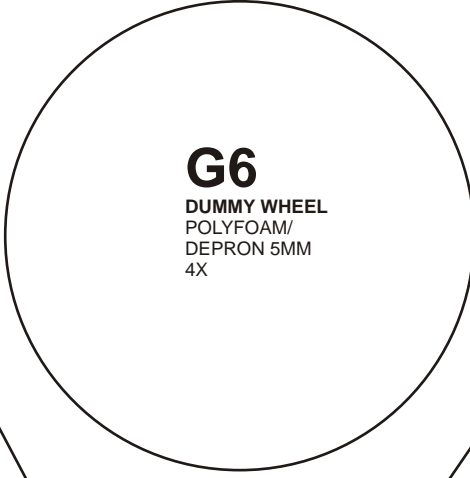

G6

DUMMY WHEEL
POLYFOAM/
DEPRON 5MM
4X

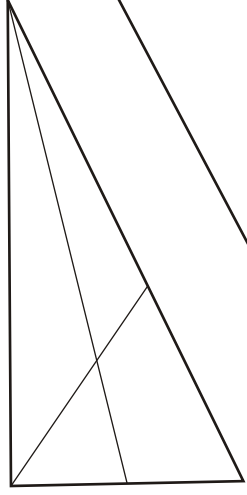

S4

VER-STAB MAST
PLYWOOD 3MM



S5

VER-STAB
POLYFOAM/
DEPRON 5MM



**Watch
Video Tutorial
for more detail
instructions**

JOIN HERE

S1



JOIN HERE

JOIN HERE

JOIN HERE

S1

G9

DUMMY LG
POLYFOAM/
DEPRON 5MM
2X

G8

DUMMY LG
POLYFOAM/
DEPRON 5MM
6X

S2

VER-STAB SPAR
POLYFOAM/ DEPRON 5MM

S3

VER-STAB SPAR
POLYFOAM/ DEPRON 5MM

JOIN HERE

JOIN HERE

JOIN HERE

S1

JOIN HERE



F37 ACCESSORIES
MICA 0.3MM

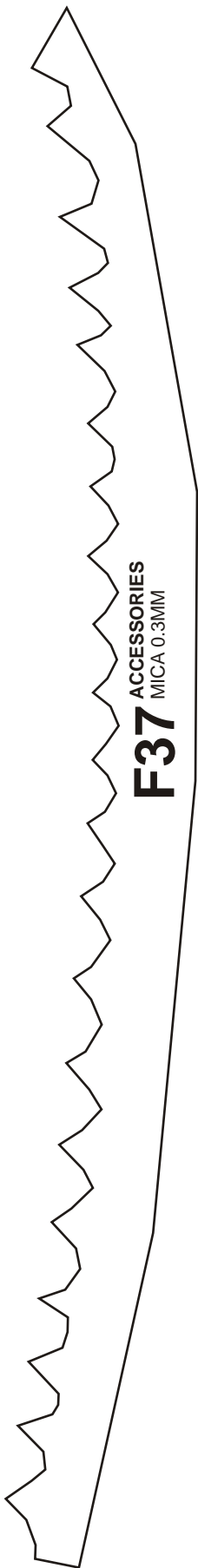

F37 ACCESSORIES
MICA 0.3MM

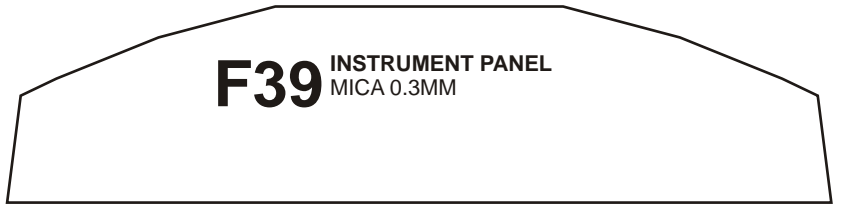

F39 INSTRUMENT PANEL
MICA 0.3MM

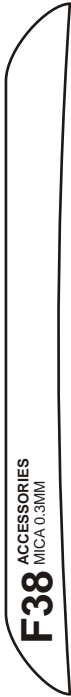

F38 ACCESSORIES
MICA 0.3MM

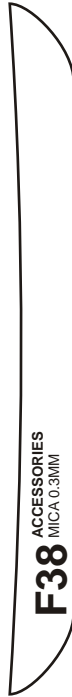

F38 ACCESSORIES
MICA 0.3MM

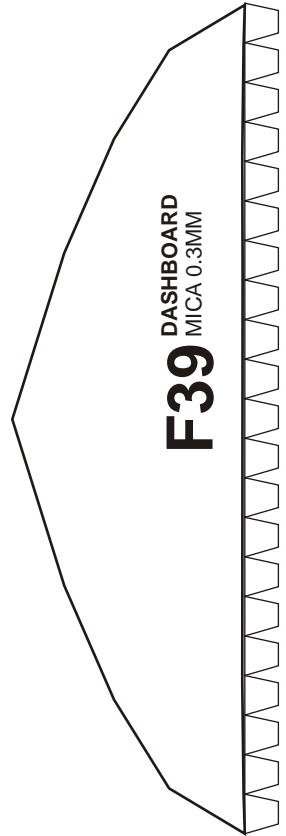

F39 DASHBOARD
MICA 0.3MM

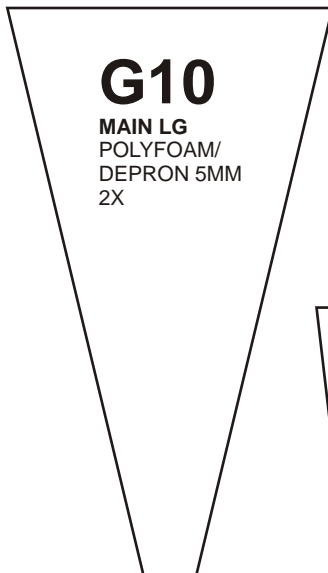

G10
MAIN LG
POLYFOAM/
DEPRON 5MM
2X



Watch
Video Tutorial
for more detail
instructions

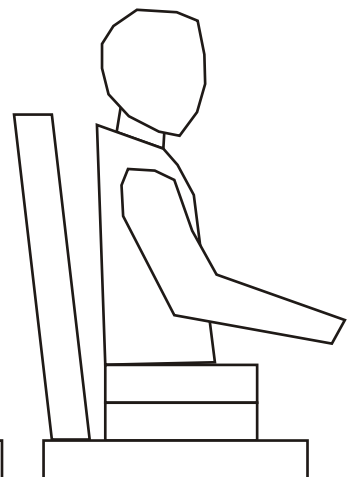
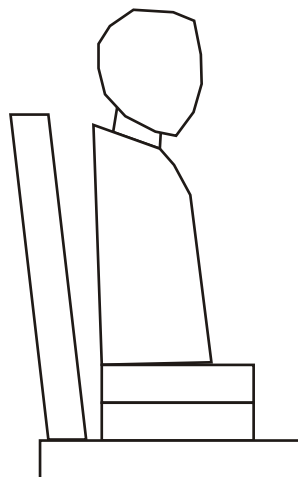

PILOT FIGURE