



Model : 10/2020



F-35C LIGHTNING II

950mm - EDF 70mm

Specs :

1. Wingspan 950mm / 37.4inches
2. Flying weight : 1235 grams/ 43.6 oz
3. Wing loading : 37 gram/dm² - 12.1 oz/sq.ft.
4. Wing cube loading : 6.4
5. Wing Area : 33.37 dm² / 517 sq.in.
6. CG : 11.5 cm from the begining of the wing root

Electronics

- QX EDF Motor 70mm 6 blades 3500kv
- ESC 70A
- Battery Lipo 4S 2200mAh minimum 60C
- 6 plastic gear 9 gram servos
- 2 metal gear 9 gram servos

Materials :

1. 5mm Depron/ Polyfoam
2. 3mm Plywood
4. 0.3mm Mica Plastic
5. hot glue
6. PVA glue
7. parchment/bread paper

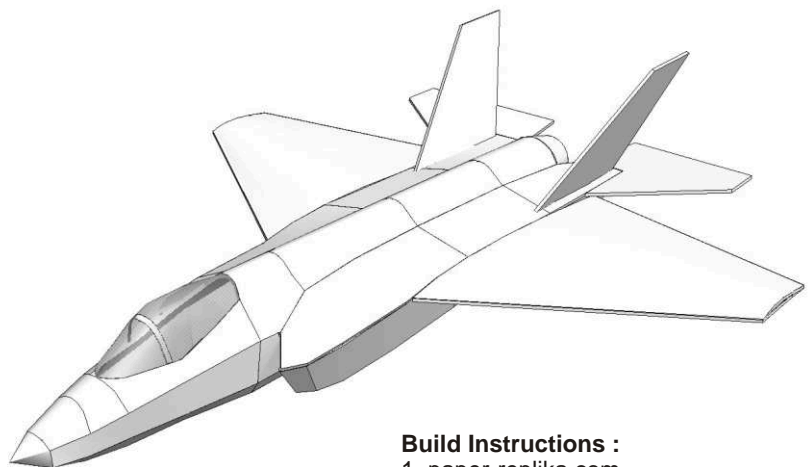

Build Instructions :

1. paper-replika.com
2. youtube channel : Julius Perdana

T1

THRUST TUBE
POLYFOAM/ DEPRON 3MM

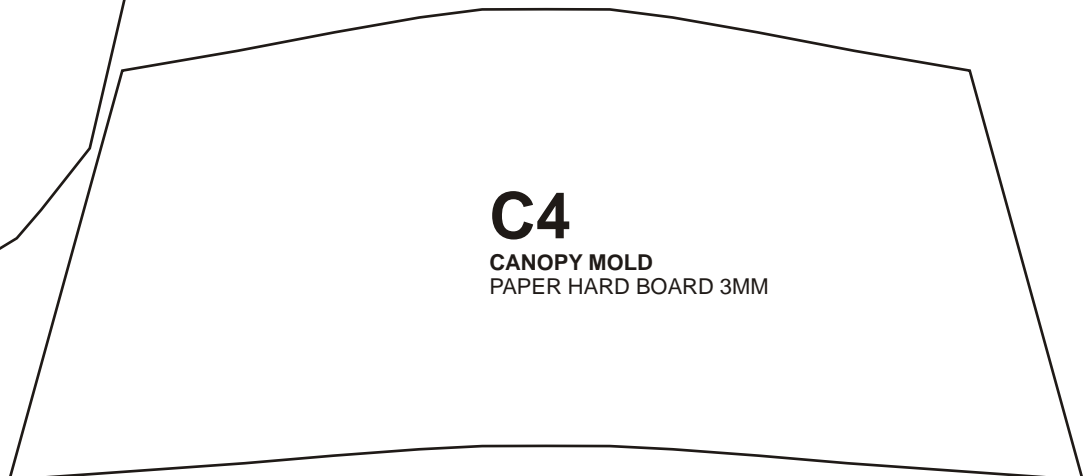
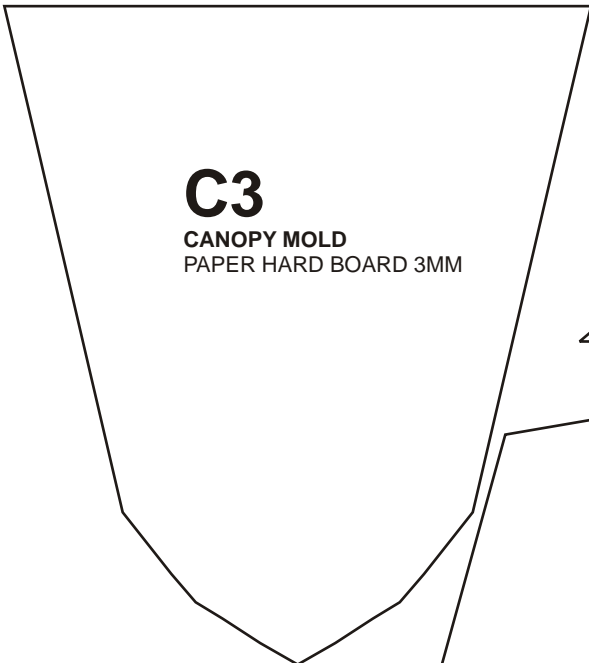
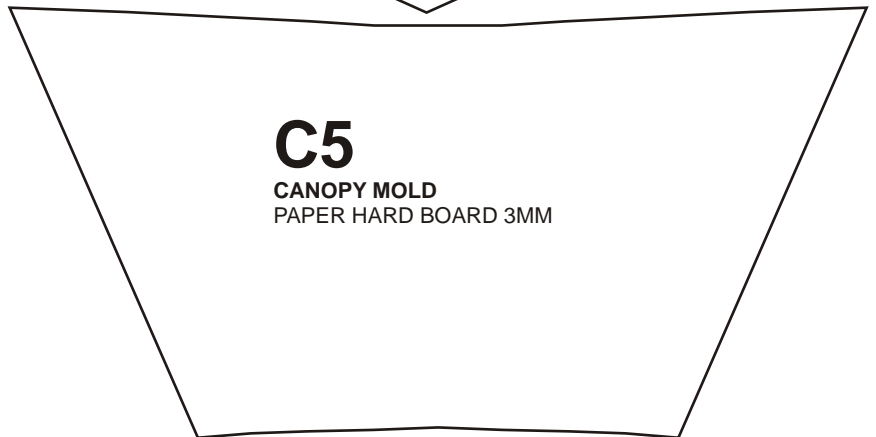
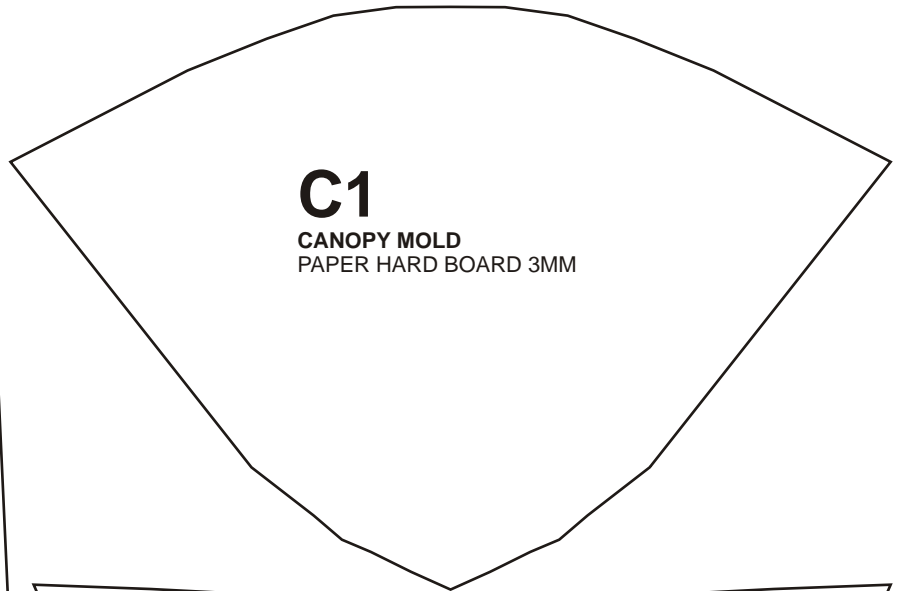

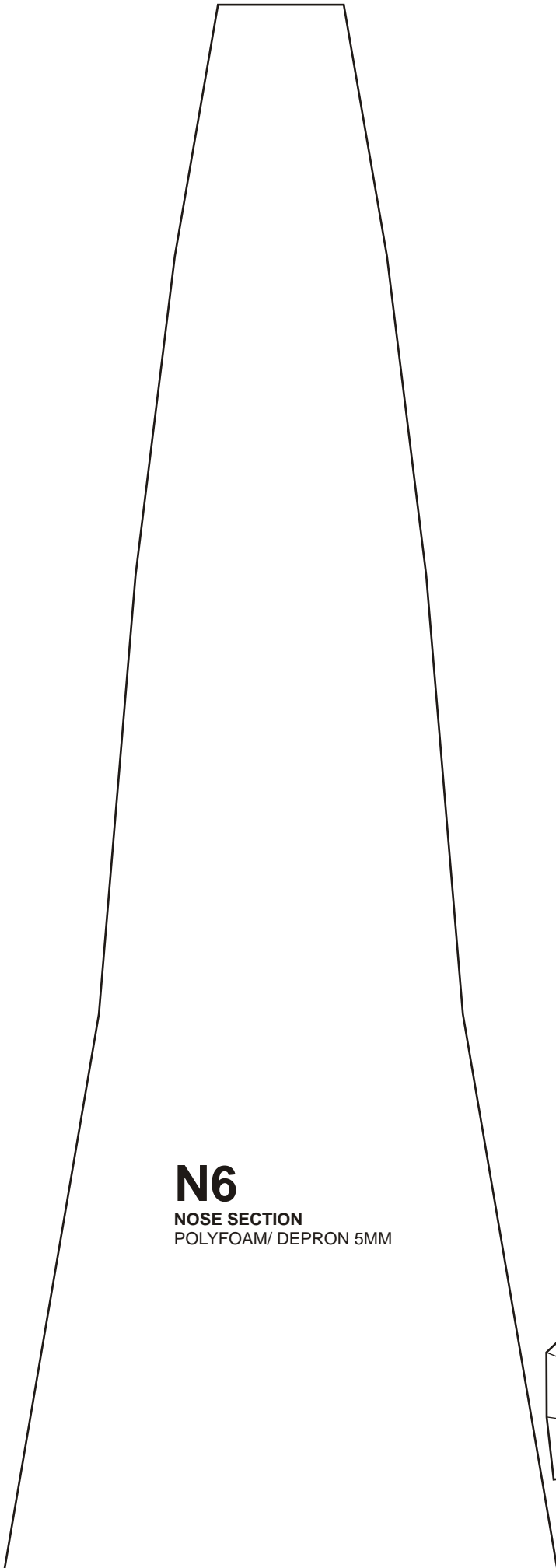

N6
NOSE SECTION
POLYFOAM/ DEPRON 5MM

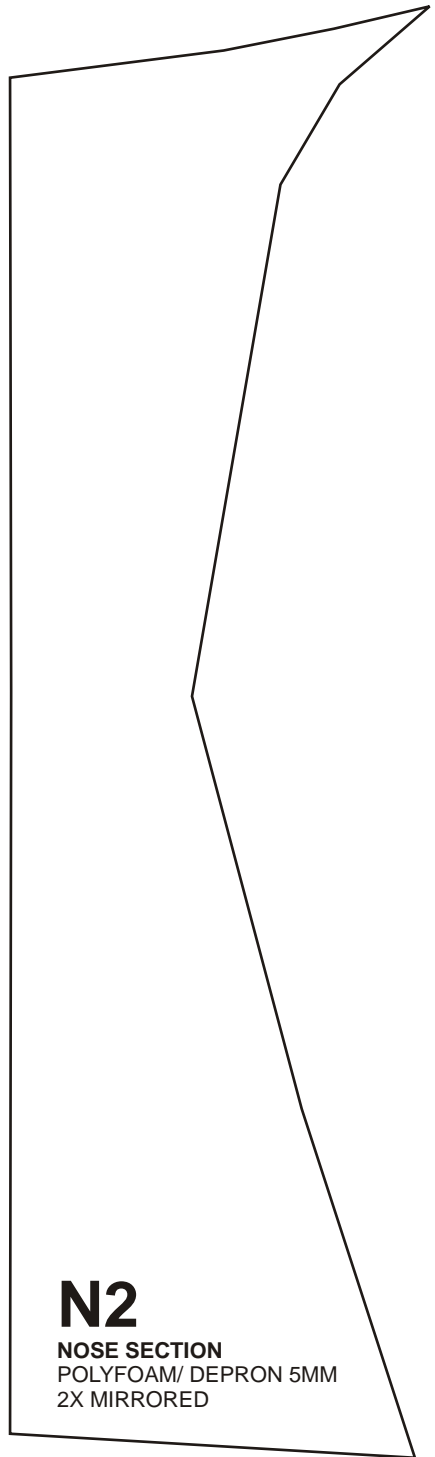

N2
NOSE SECTION
POLYFOAM/ DEPRON 5MM
2X MIRRORED

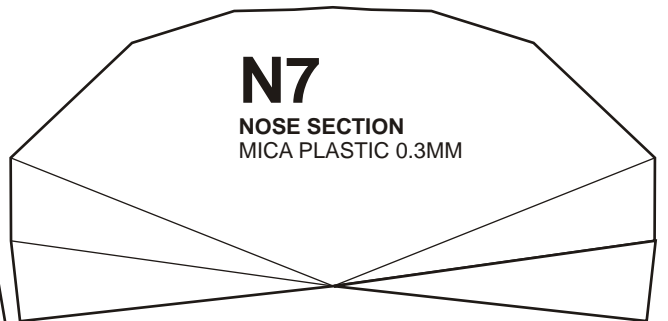

N7
NOSE SECTION
MICA PLASTIC 0.3MM

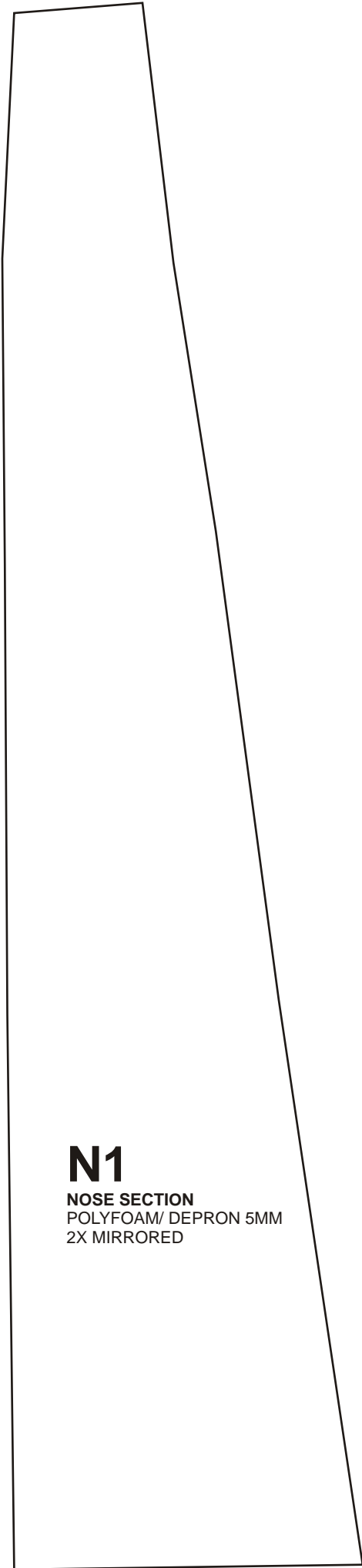

N1

NOSE SECTION
POLYFOAM/ DEPRON 5MM
2X MIRRORED

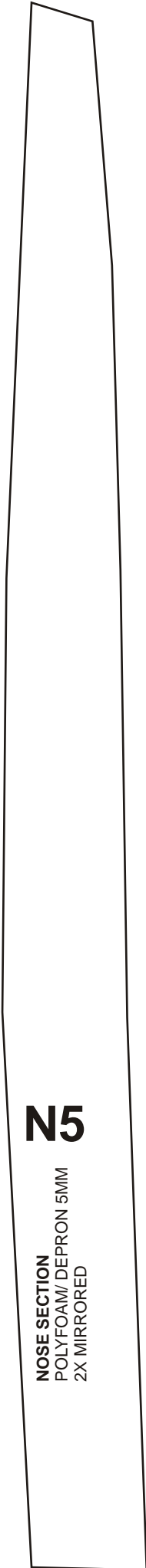

N5

NOSE SECTION
POLYFOAM/ DEPRON 5MM
2X MIRRORED

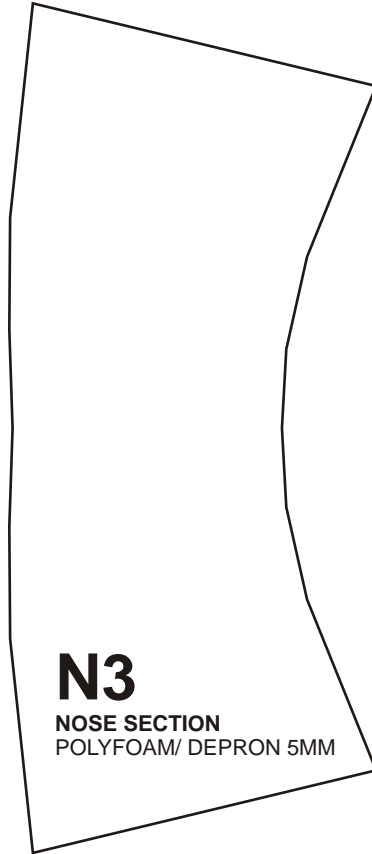

N3

NOSE SECTION
POLYFOAM/ DEPRON 5MM

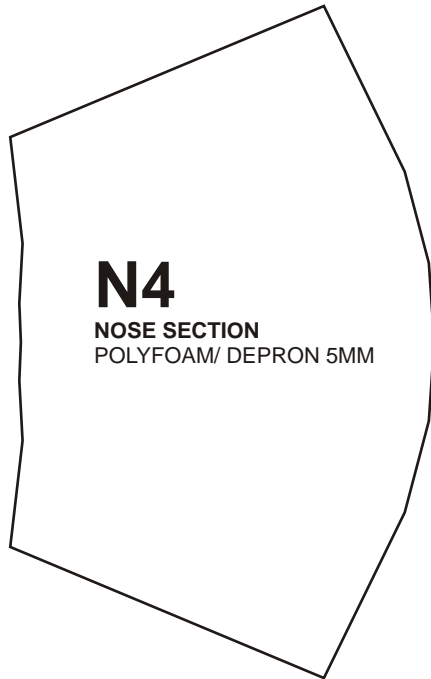

N4

NOSE SECTION
POLYFOAM/ DEPRON 5MM

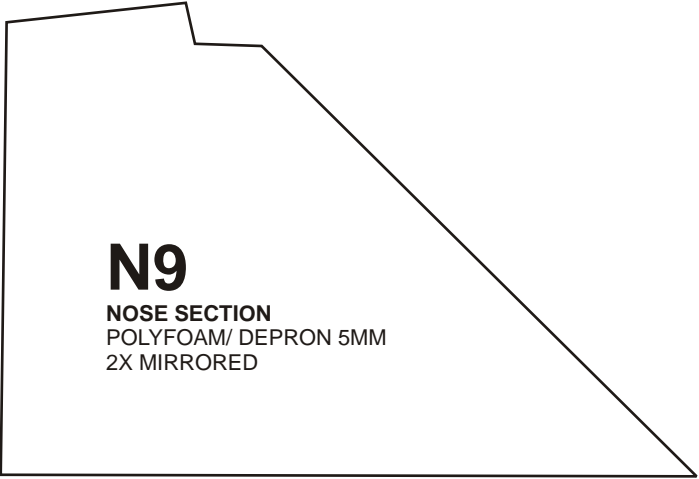
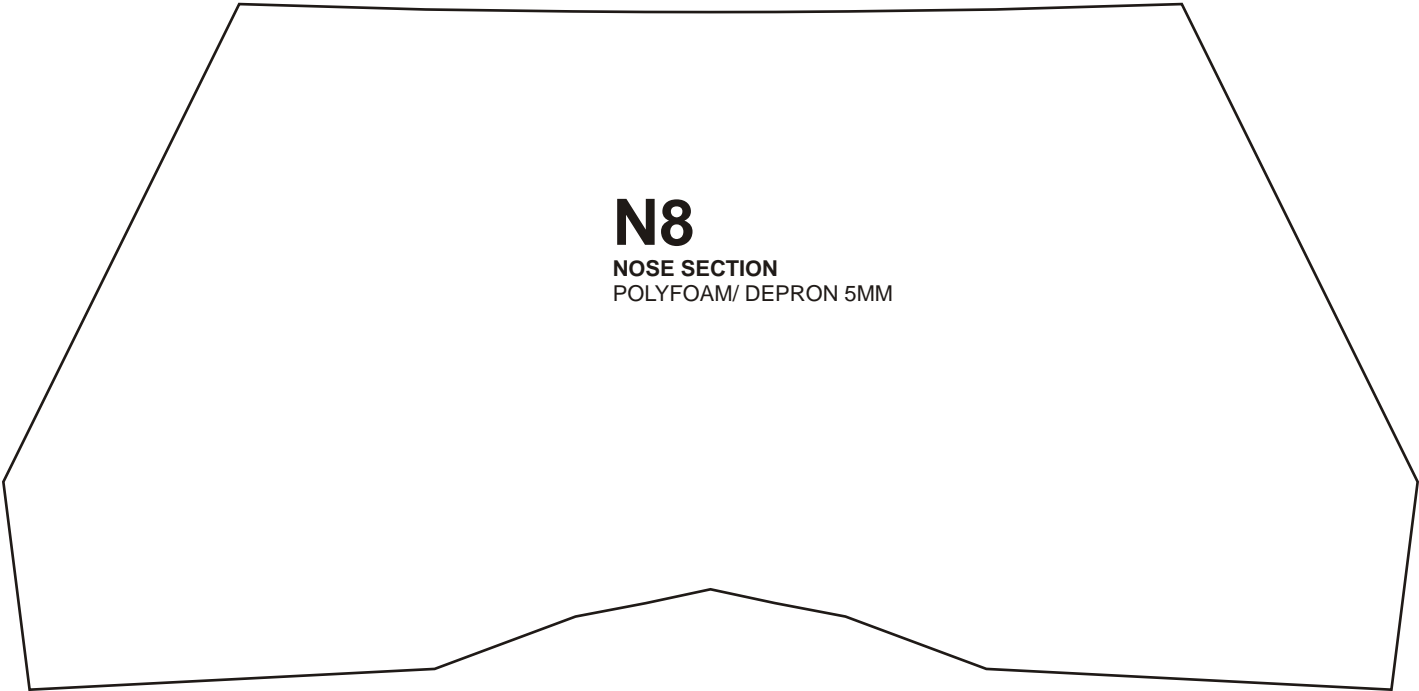

F1
FUSELAGE
POLYFOAM/ DEPRON 5MM

FRONT
↑

F11
FUSELAGE FORMER
POLYFOAM/ DEPRON 5MM
2X

JOIN HERE

F2

F2

FUSELAGE
POLYFOAM/ DEPRON 5MM
2X MIRRORED

F10

FUSELAGE
POLYFOAM/ DEPRON 5MM
2X MIRRORED

JOIN HERE

JOIN HERE

F3

FUSELAGE
POLYFOAM/ DEPRON 5MM
2X MIRRORED

F9

FUSELAGE
POLYFOAM/ DEPRON 5MM
2X MIRRORED



F3

JOIN HERE

JOIN HERE

F5

JOIN HERE

F6

FUSELAGE
POLYFOAM/ DEPRON 5MM

F5

FUSELAGE
POLYFOAM/ DEPRON 5MM
2X MIRRORED

FRONT



F7

FUSELAGE
POLYFOAM/ DEPRON 5MM

F8

FUSELAGE
POLYFOAM/ DEPRON 5MM
2X MIRRORED



F21

FUSELAGE HATCH DOOR
POLYFOAM/ DEPRON 5MM



F12

FUSELAGE FORMER
POLYFOAM/ DEPRON 5MM

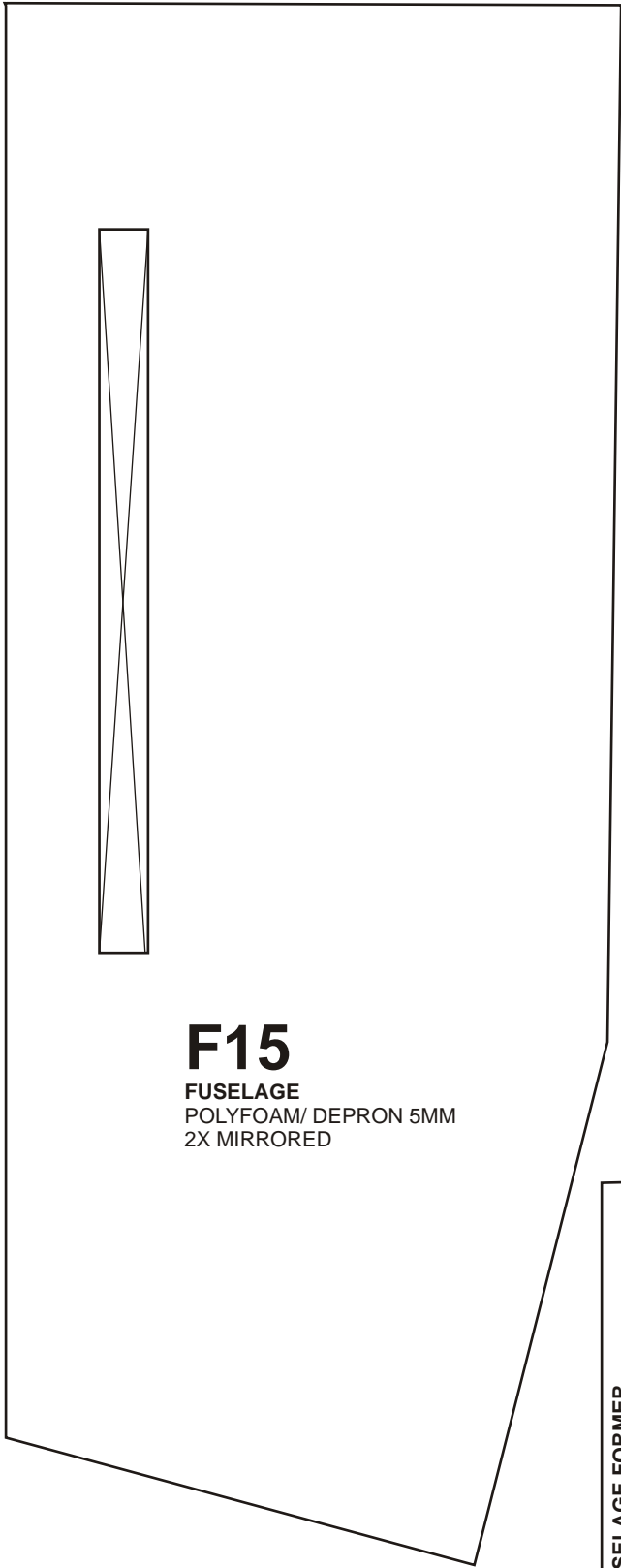

F15
FUSELAGE
POLYFOAM/ DEPRON 5MM
2X MIRRORED

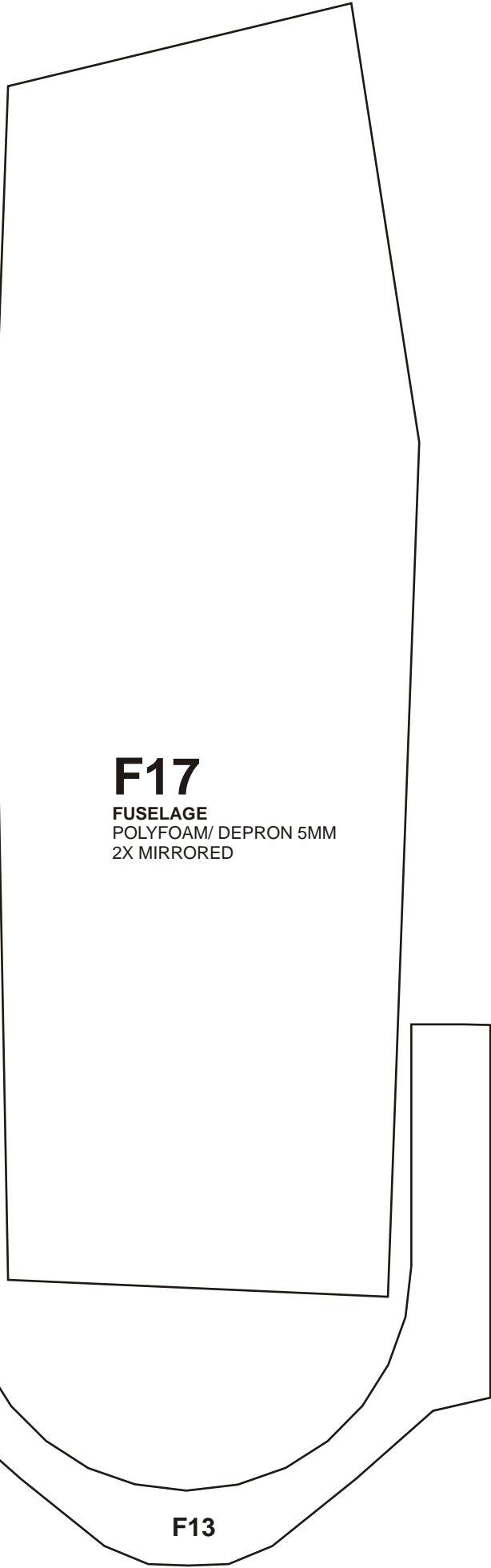

F17
FUSELAGE
POLYFOAM/ DEPRON 5MM
2X MIRRORED

FUSELAGE FORMER
PLYWOOD / HARD Balsa 3MM

F13



F14
FUSELAGE
POLYFOAM/ DEPRON 5MM

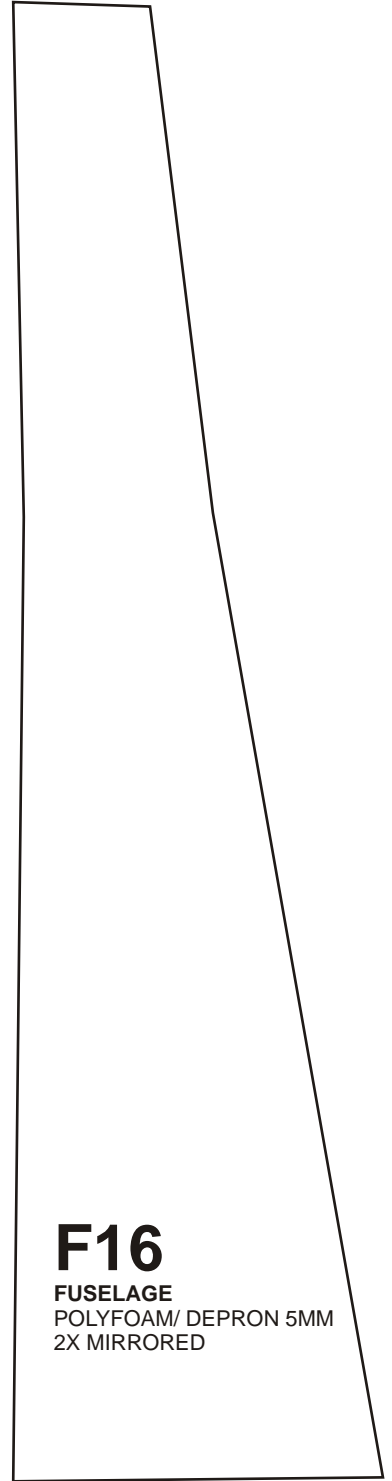

F16
FUSELAGE
POLYFOAM/ DEPRON 5MM
2X MIRRORED

JOIN HERE

W8

VERTICAL STAB
POLYFOAM/ DEPRON 5MM
2X MIRRORED

W8

JOIN HERE

JOIN HERE

W7

W7

HORIZONTAL STAB
POLYFOAM/ DEPRON 5MM
2X MIRRORED

JOIN HERE

F19

FUSELAGE
POLYFOAM/ DEPRON 5MM
2X MIRRORED

F20

FUSELAGE
POLYFOAM/ DEPRON 5MM
2X MIRRORED

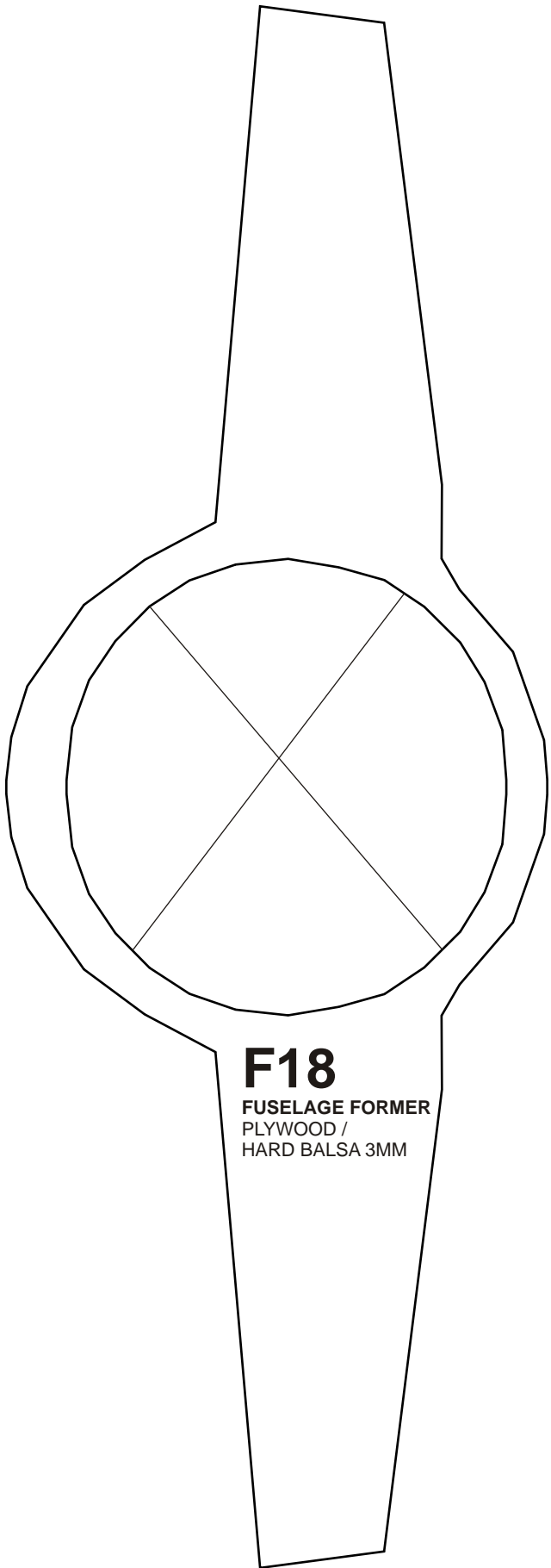

F18

FUSELAGE FORMER
PLYWOOD /
HARD Balsa 3MM

W1

BOTTOM WING
POLYFOAM/ DEPRON 5MM
2X MIRRORED

JOIN HERE

JOIN HERE

JOIN HERE

W1

JOIN HERE

JOIN HERE

W1

JOIN HERE

W3

WING SPAR
POLYFOAM/ DEPRON 5MM
2X MIRRORED

JOIN HERE

W4

WING SPAR POLYFOAM/ DEPRON 5MM 2X MIRRORED

JOIN HERE

W2

WING FORMER
POLYFOAM/ DEPRON 5MM
2X MIRRORED

JOIN HERE

JOIN HERE

JOIN HERE

W1

JOIN HERE **W3**

JOIN HERE **W4**

JOIN HERE **W2**

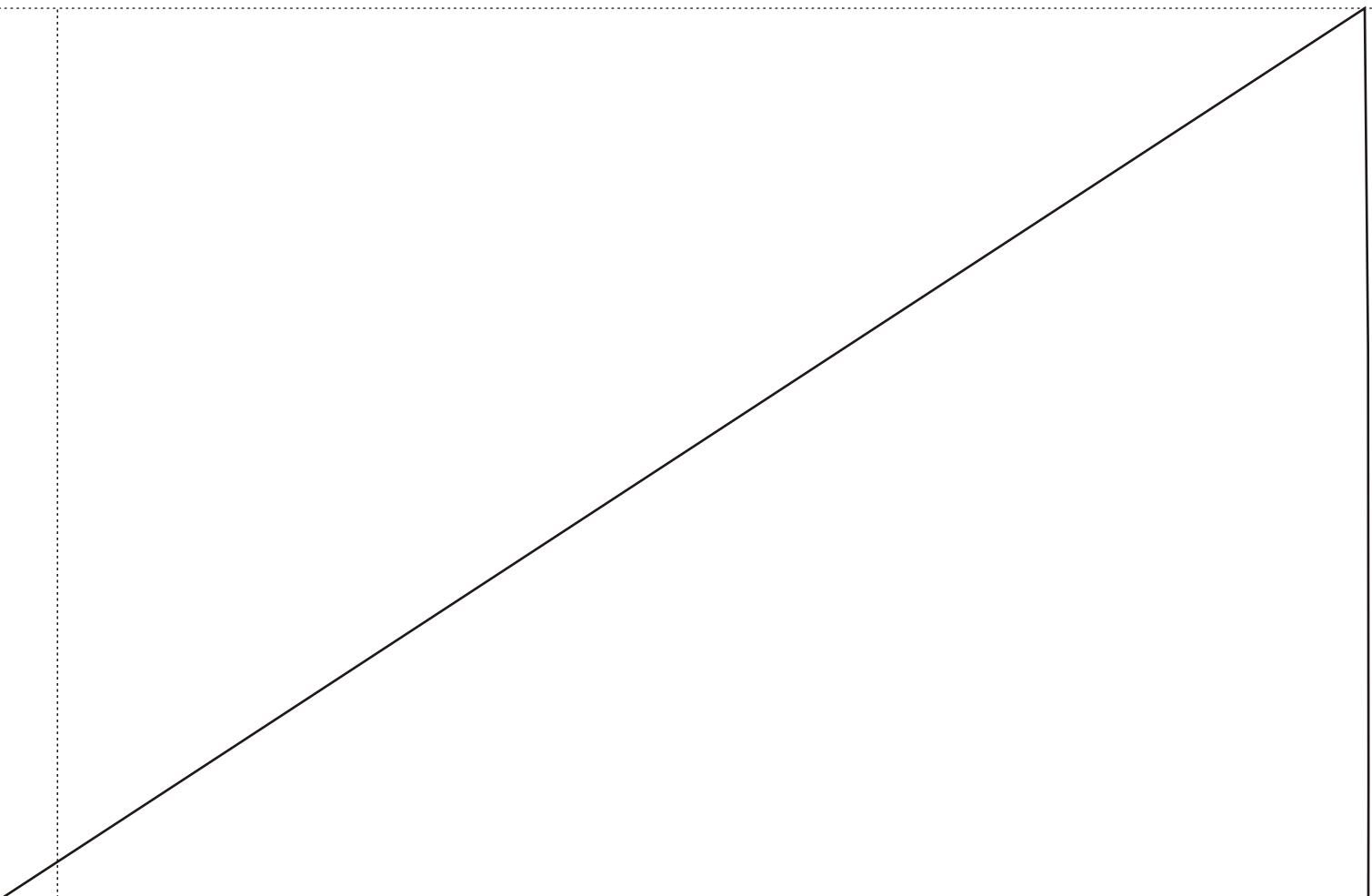

W5

TOP WING
POLYFOAM/ DEPRON 5MM
2X MIRRORED

JOIN HERE

JOIN HERE



W5

JOIN HERE

JOIN HERE

JOIN HERE

W5

JOIN HERE

JOIN HERE

JOIN HERE

W5

JOIN HERE

W6

W6
AILERON
TRACING GUIDE

JOIN HERE

F25
2X

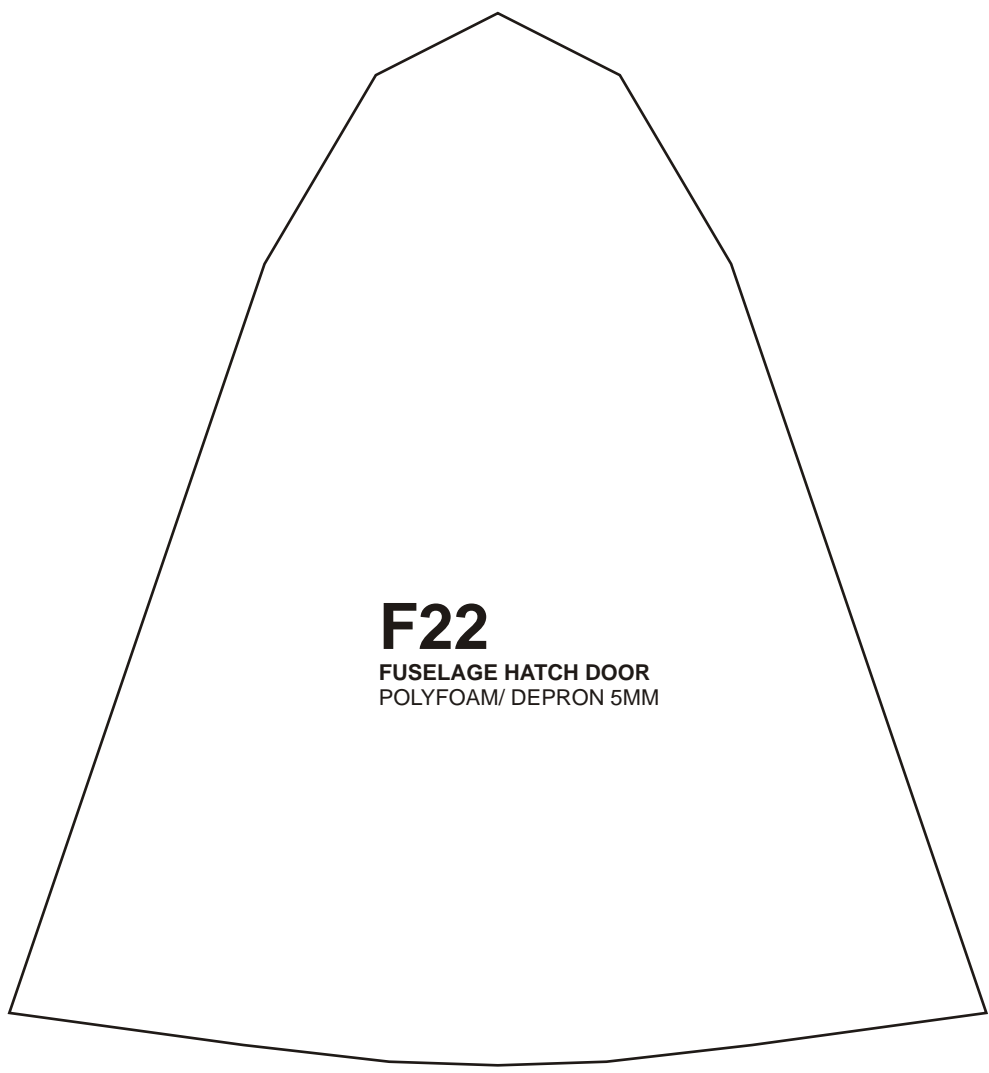

F22
FUSELAGE HATCH DOOR
POLYFOAM/ DEPRON 5MM



F23
FUSELAGE HATCH DOOR
POLYFOAM/ DEPRON 5MM

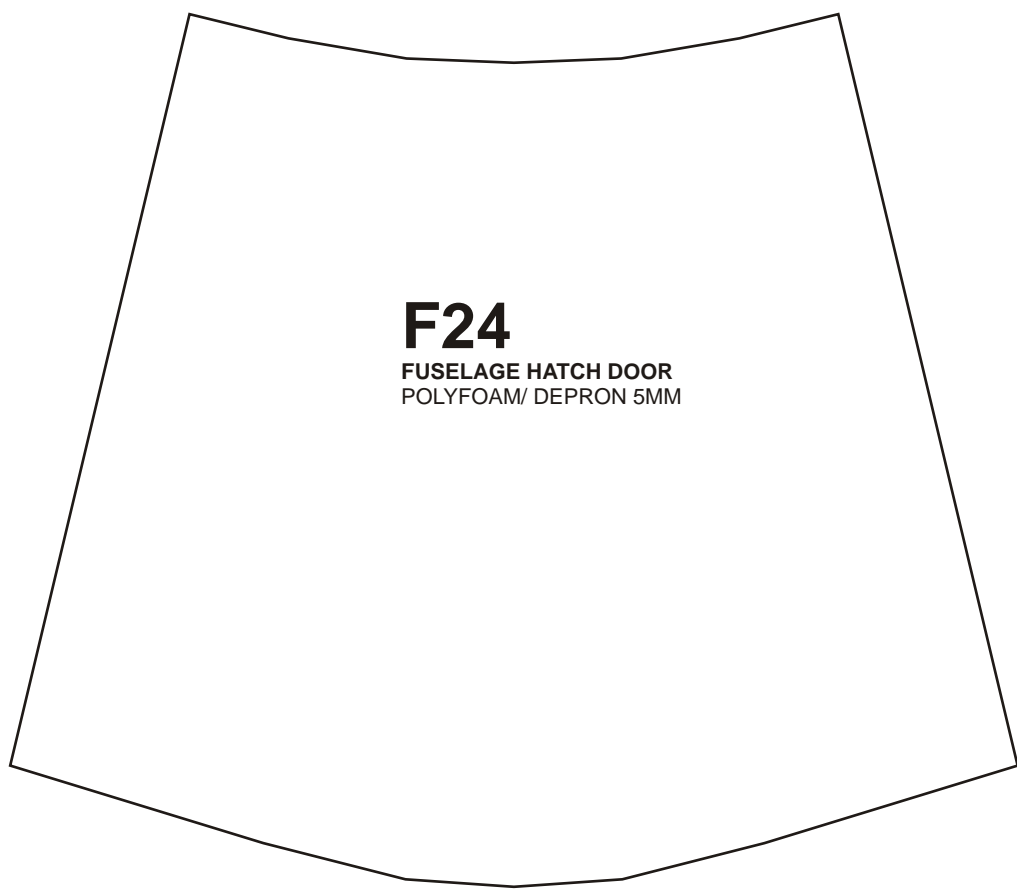

F24
FUSELAGE HATCH DOOR
POLYFOAM/ DEPRON 5MM

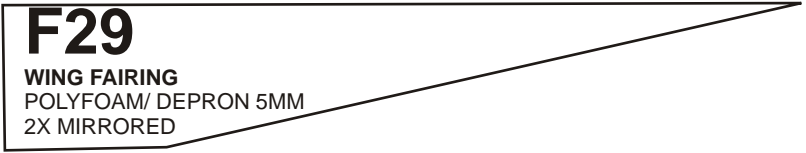
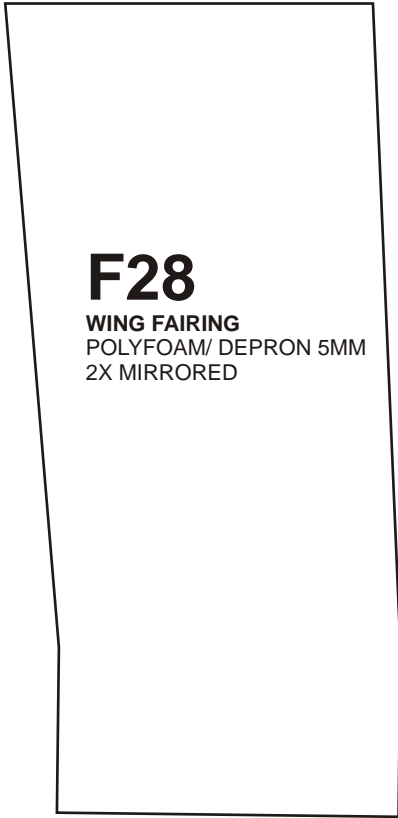

| | |
|--------------|--------------|
| 1. AIL LEFT | 1. AIL LEFT |
| 2. ELE LEFT | 2. ELE LEFT |
| 3. ESC | 3. ESC |
| 4. STEER | 4. STEER |
| 5. GEAR | 5. GEAR |
| 6. AIL RIGHT | 6. AIL RIGHT |
| 7. ELE RIGHT | 7. ELE RIGHT |

