



Model : 21/2020



# P-51D Mustang

**1100mm**

## Specs :

1. Wingspan 1100mm / 43.3 inches
2. Flying weight : 1060 grams/ 37.4 oz
3. Wing loading : 47.5 gram/dm<sup>2</sup> - 15.6 oz/sq.ft.
4. Wing cube loading : 10
5. Wing Area : 22.3 dm<sup>2</sup> / 346 sq.in.
6. CG : 4 cm

## Electronics

- motor 35 - 650kv - 1200kv brushless motor
- Tested with DXW 3536 1200kv brushless motor prop 10x6x3
- ESC 50A
- Battery Lipo 3S 2200mah
- 4 metal gear 9 gram servos (micro servo)
- 1 metal gear standard servo

## Materials :

1. 5mm Depron/ Polyfoam
2. 3mm + 7mm Plywood
4. 0.3mm + 0.5mm Mica Plastic
5. hot glue, UHU glue, CA glue
6. packing tap/wax paper/ laminating film

## Build Instructions :

1. [paper-replika.com](http://paper-replika.com)
2. youtube channel : Julius Perdana

# RETRACT LANDING GEAR

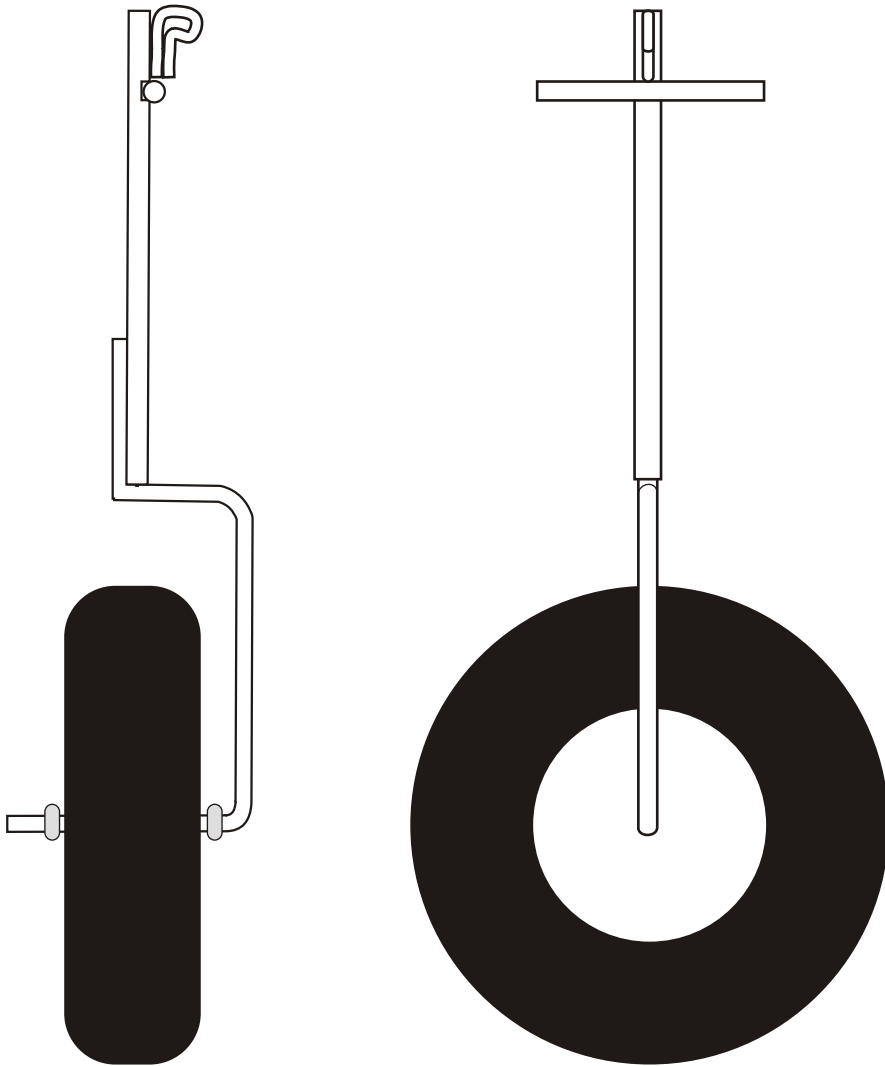

**G6**

LG BASE  
PLYWOOD 3MM ⊗

**G7** ⊗  
LG BASE  
PLYWOOD 7MM

**G7** ⊗  
LG BASE  
PLYWOOD 7MM

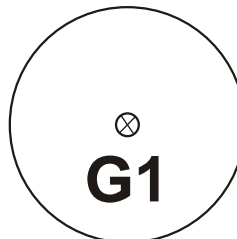
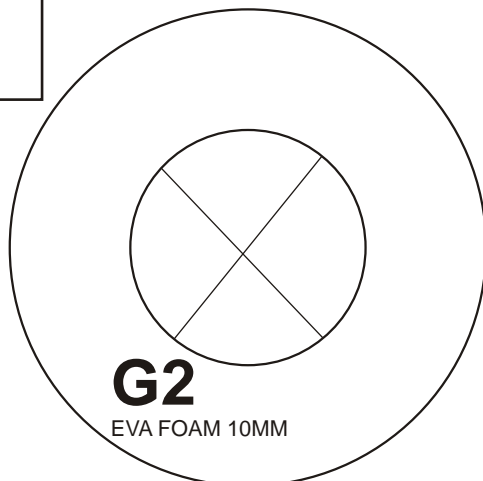

## FIXED LANDING GEAR

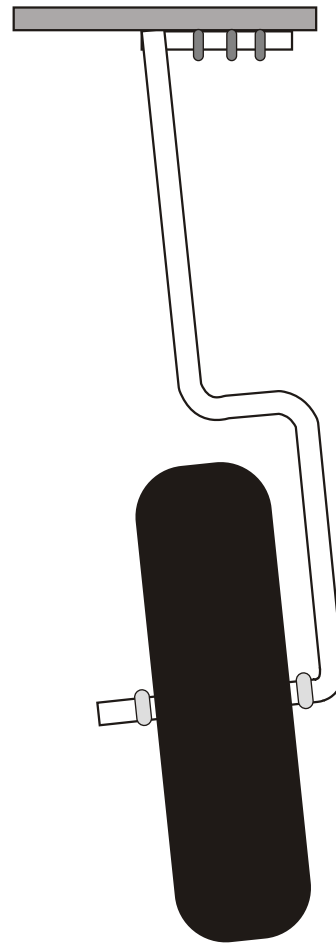
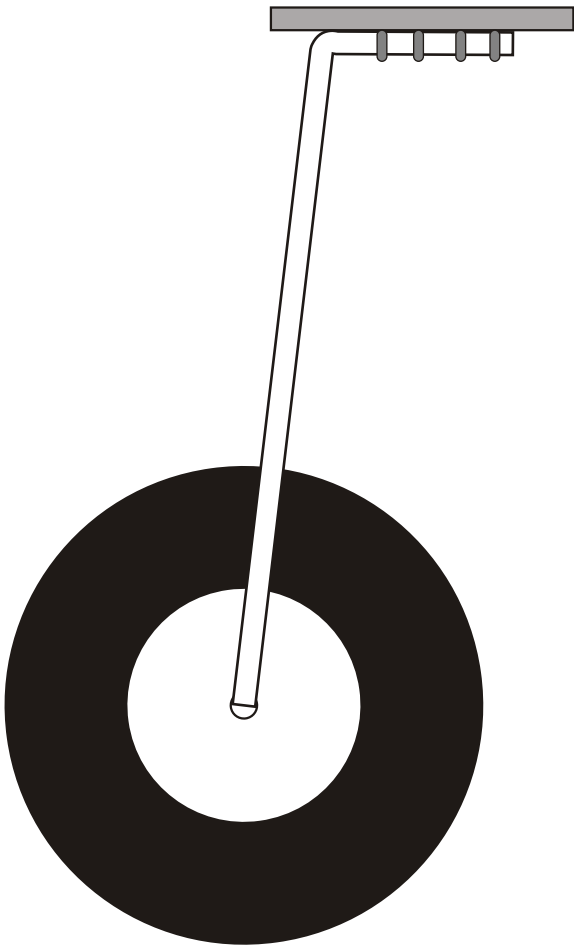

<b>G4</b> LG BASE PLYWOOD 7MM ⊗	<b>G4</b> LG BASE PLYWOOD 7MM ⊗	<b>G5</b> STOPPER PLYWOOD 7MM <b>G5</b> STOPPER PLYWOOD 7MM
<b>G3</b> LG BASE PLYWOOD 7MM ⊗	<b>G3</b> LG BASE PLYWOOD 7MM ⊗	



JOIN HERE

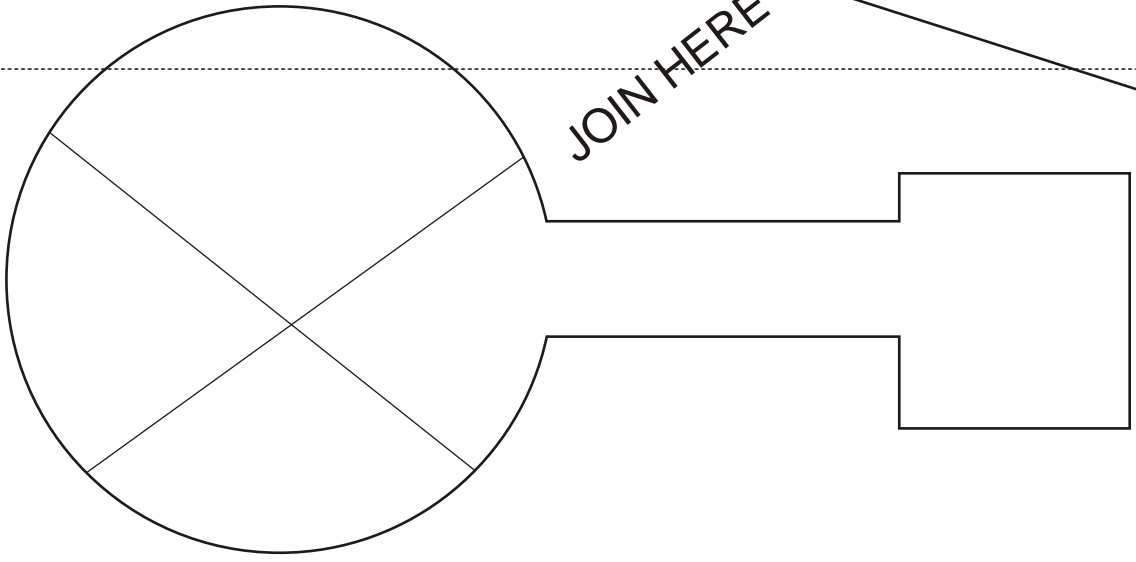

JOIN HERE

# W1

WING BASE  
POLYFOAM/ DEPRON 5MM  
2X MIRRORED

W3 JOIN HERE

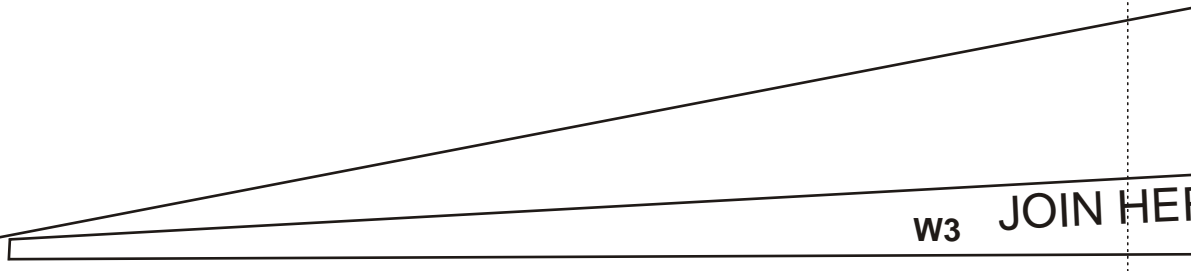

JOIN HERE

W1

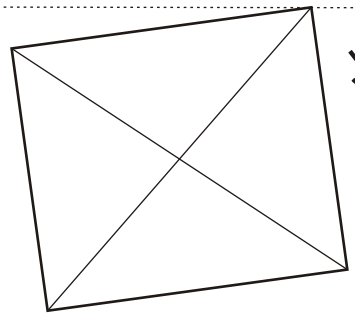

JOIN HERE

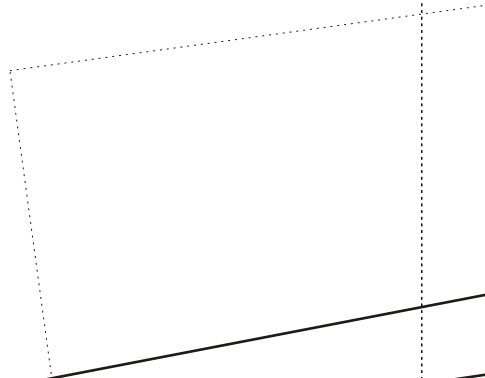

W2

JOIN HERE

W3

JOIN HERE

JOIN HERE

JOIN HERE

**W1**

JOIN HERE

**W2**

AIRFOIL FORMER  
POLYFOAM/ DEPRON 5MM  
2X

JOIN HERE

**W3**

FOAM SPAR  
POLYFOAM/ DEPRON 5MM  
2X

**F29** 2X

**D3**

AIR INTAKE  
POLYFOAM/  
DEPRON 5MM

**D5**

AIR INTAKE  
POLYFOAM/  
DEPRON 5MM

**D4**

AIR INTAKE  
POLYFOAM/  
DEPRON 5MM  
2X

**F28**

TAIL  
POLYFOAM/  
DEPRON 5MM

**T4**

COCKPIT  
GUIDE

**W1**

JOIN HERE

W6

JOIN HERE

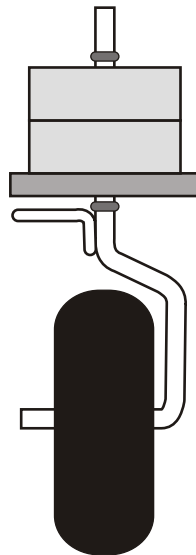
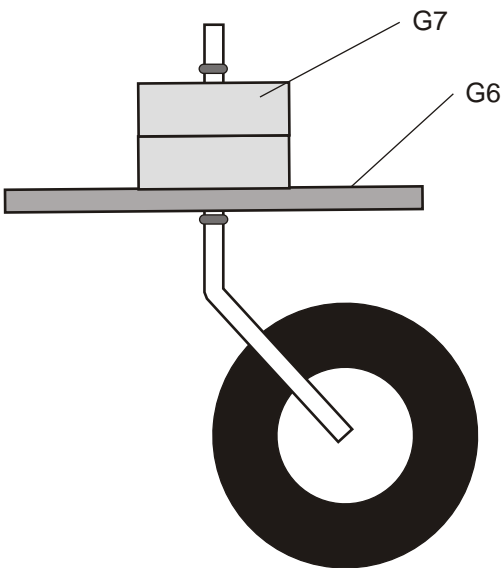



JOIN HERE

JOIN HERE

W6

JOIN HERE

JOIN HERE

# W6

WING TOP  
POLYFOAM/ DEPRON 5MM  
2X MIRRORED

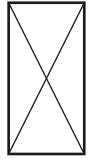

JOIN HERE

W7

**W5**

LG BASE  
PLYWOOD 3MM

**W5**

LG BASE  
PLYWOOD 3MM

**W4**

LG BASE  
PLYWOOD 3MM

**W4**

LG BASE  
PLYWOOD 3MM

**F30**

SERVO PLATFORM  
PLYWOOD 5MM

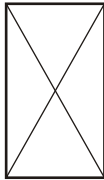
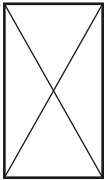

**W8**

SERVO PLATFORM  
PLYWOOD 3MM

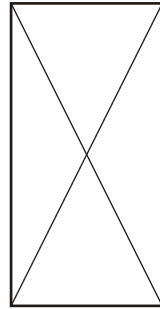

W6

JOIN HERE

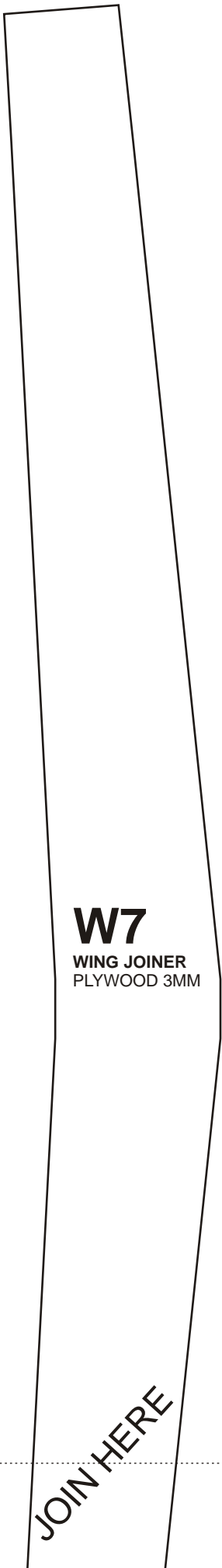

**W7**  
WING JOINER  
PLYWOOD 3MM

JOIN HERE

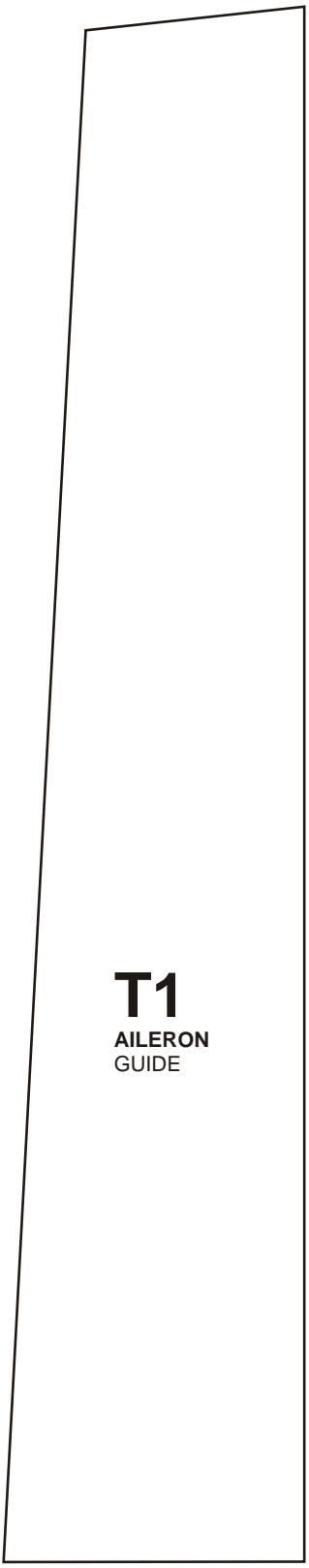

**T1**  
AILERON  
GUIDE

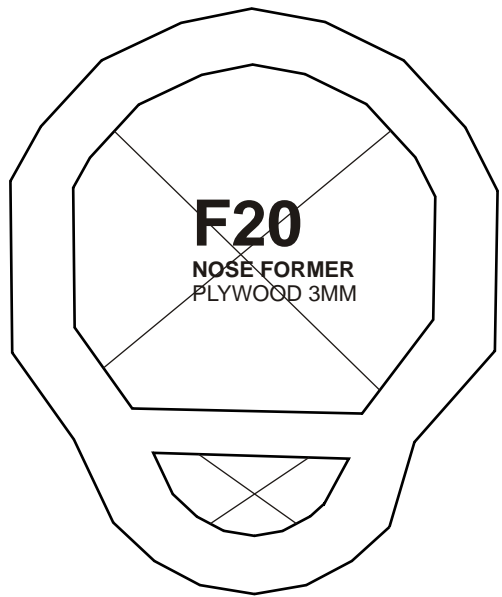

**F20**  
NOSE FORMER  
PLYWOOD 3MM



**C2**  
CANOPY  
MICA PLASTIC  
0.3 - 0.5 MM

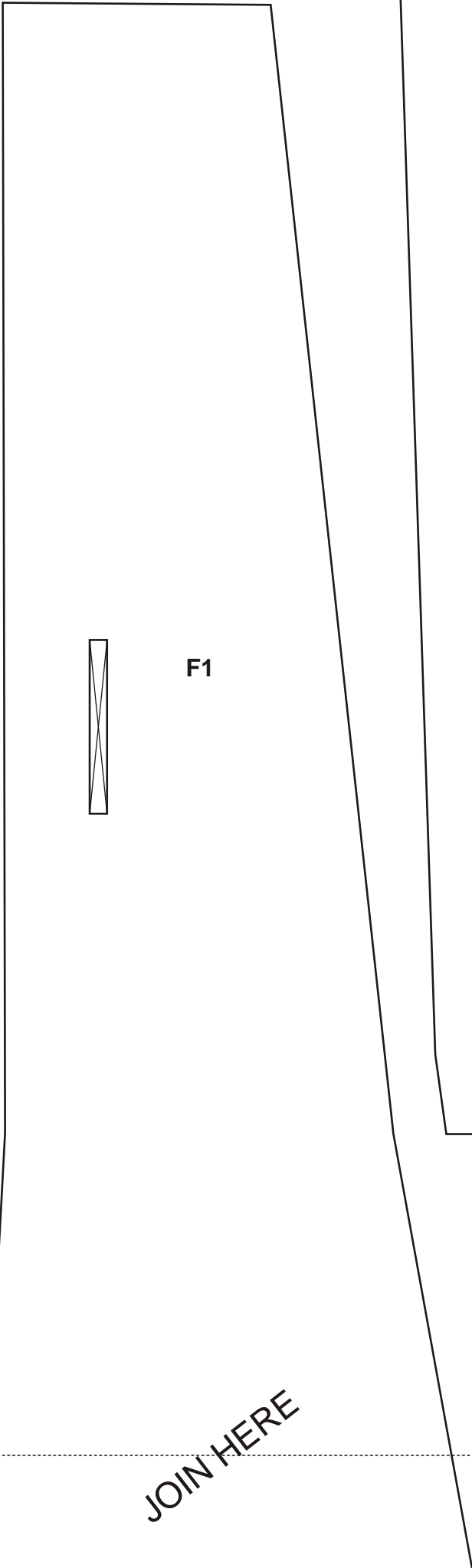

**F1**



JOIN HERE

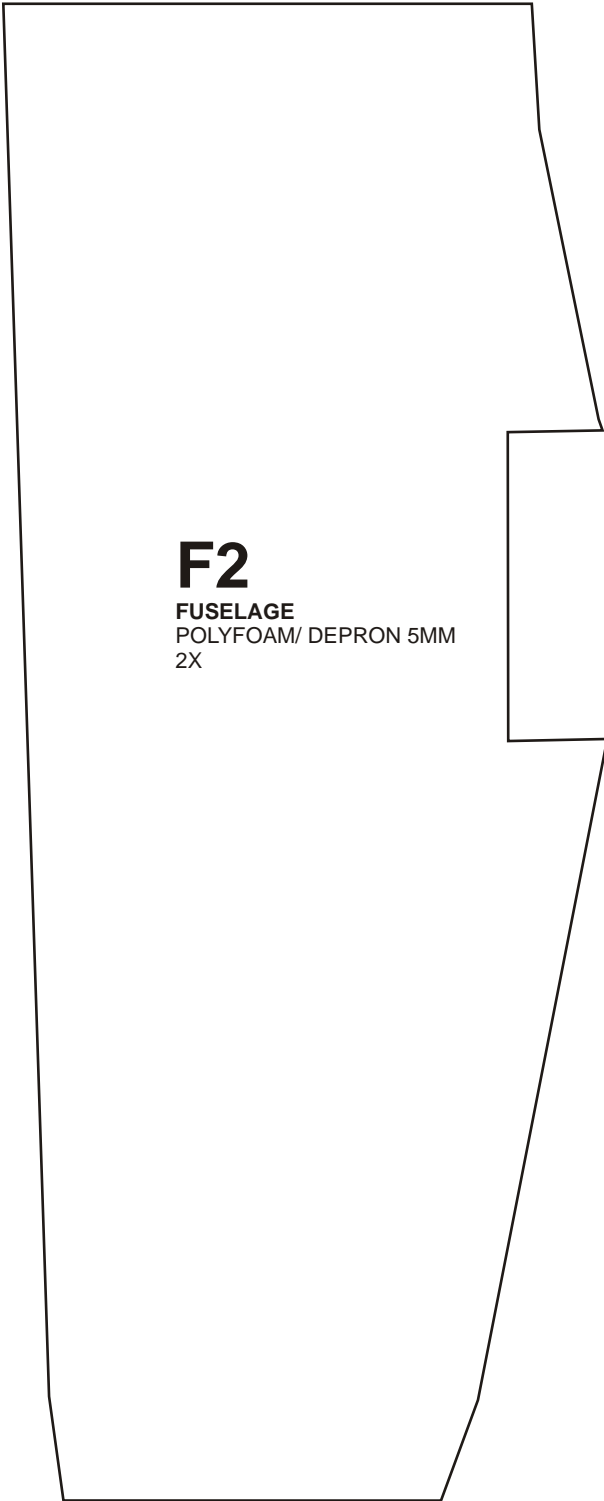

**F2**

**FUSELAGE**  
POLYFOAM/ DEPRON 5MM  
2X

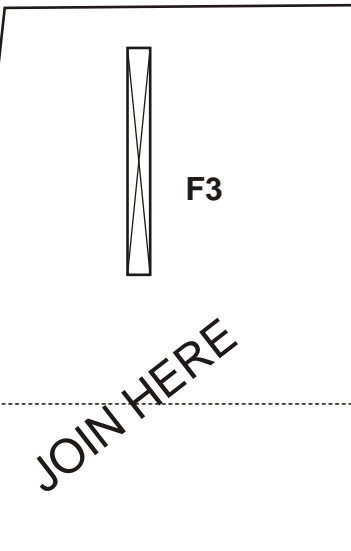

**F3**



JOIN HERE

JOIN HERE

JOIN HERE

F1

F3



JOIN HERE

JOIN HERE

JOIN HERE

JOIN HERE

**F1**

FUSELAGE WALL  
POLYFOAM/ DEPRON 5MM

**F3**

FUSELAGE WALL  
POLYFOAM/ DEPRON 5MM

JOIN HERE

JOIN HERE

JOIN HERE

F1

JOIN HERE

**F5**

FUSELAGE FORMER  
POLYFOAM/ DEPRON 5MM

F3

**F4**

FUSELAGE FORMER  
POLYFOAM/ DEPRON 5MM



**F8**

**FUSELAGE**  
POLYFOAM/ DEPRON 5MM

**F6**

**FUSELAGE**  
POLYFOAM/ DEPRON 5MM  
2X

**F7**

**FUSELAGE**  
POLYFOAM/ DEPRON 5MM

**F10**

**BATTERY COMPARTMENT**  
POLYFOAM/ DEPRON 5MM  
2X

**F9**

**BATTERY COMPARTMENT**  
POLYFOAM/ DEPRON 5MM  
2X

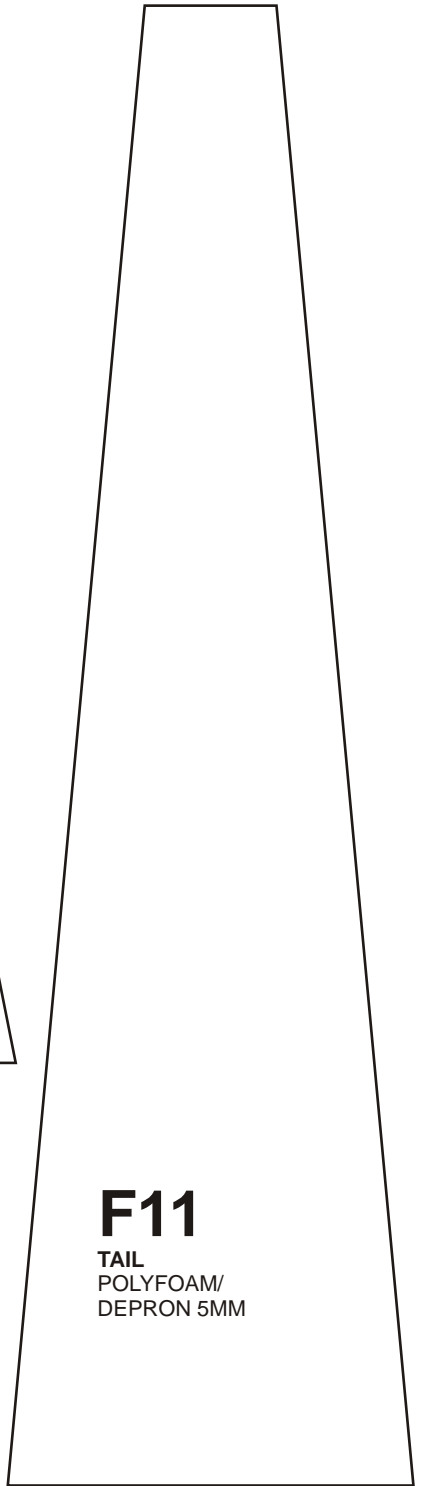
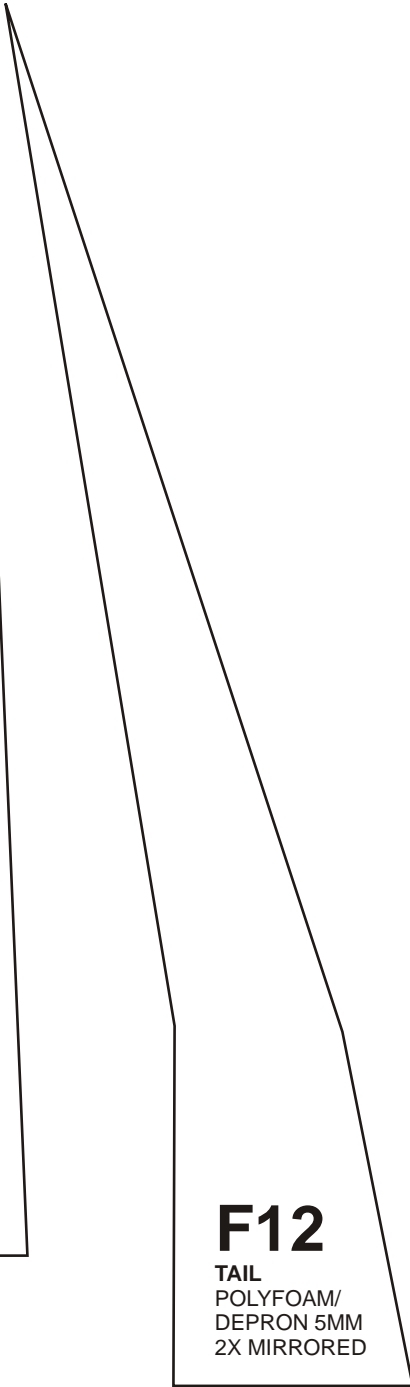
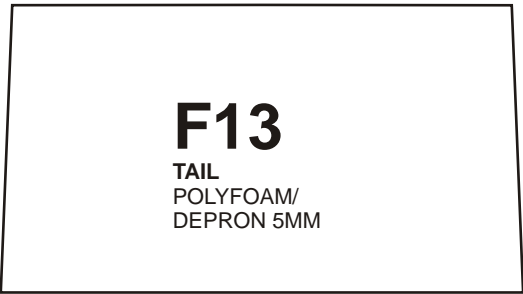
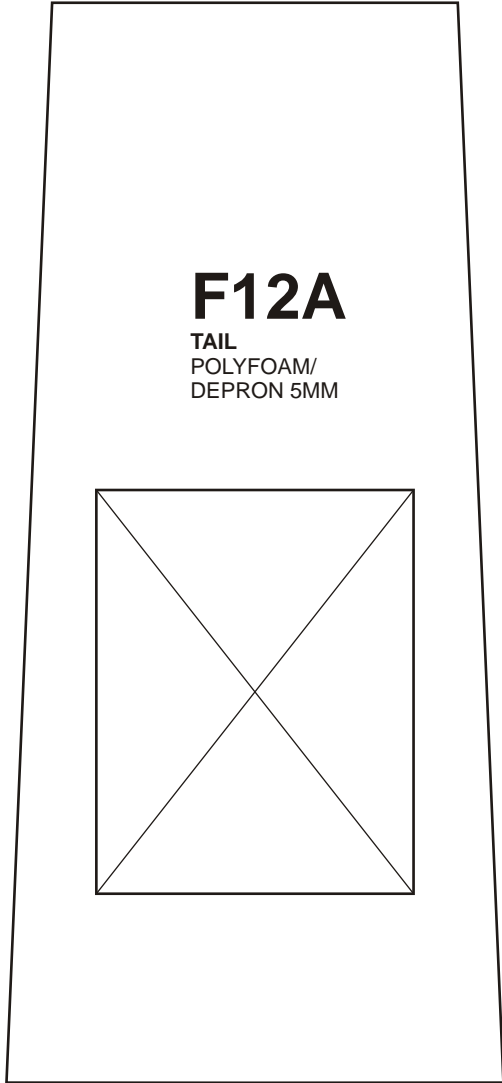

**F15**

NOSE  
POLYFOAM/  
DEPRON 5MM

**F14**

NOSE  
POLYFOAM/  
DEPRON 5MM

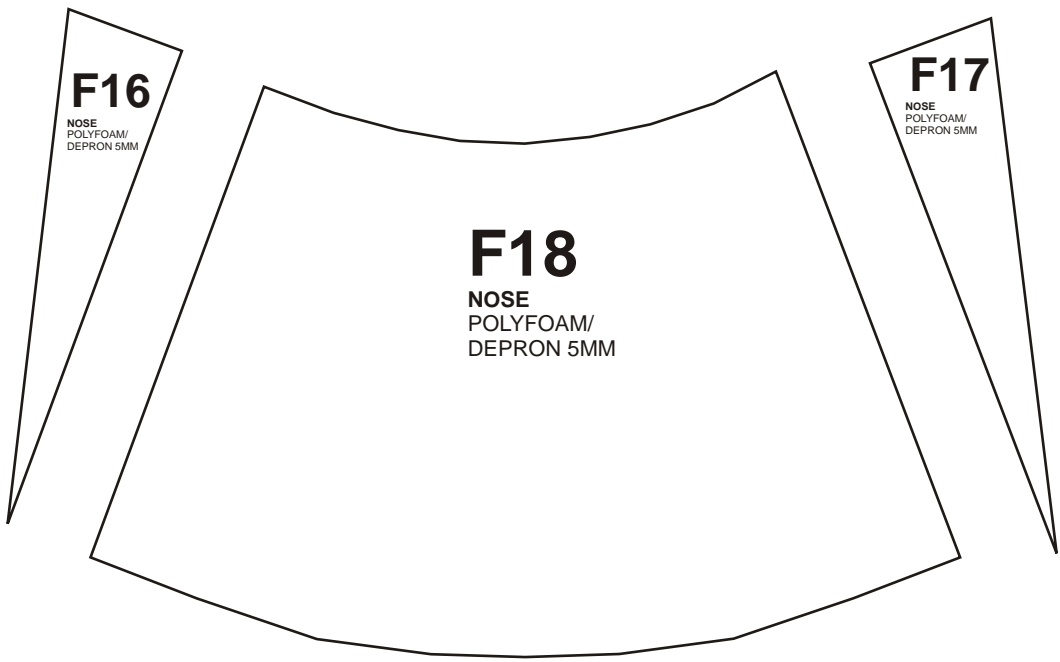
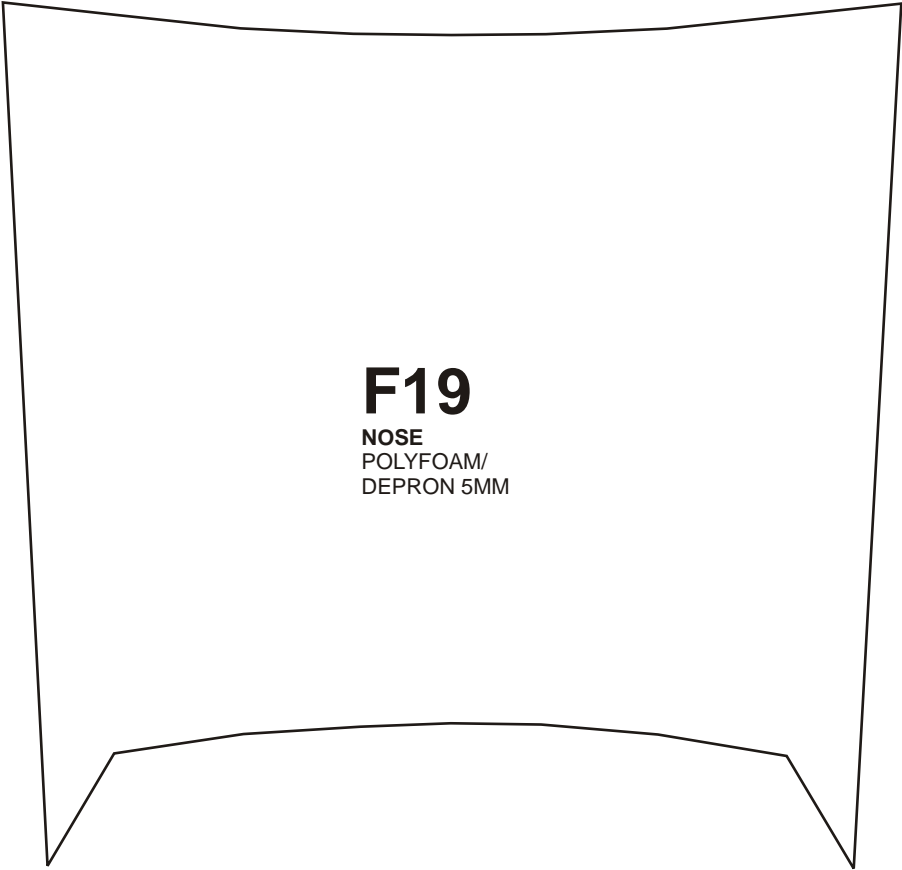

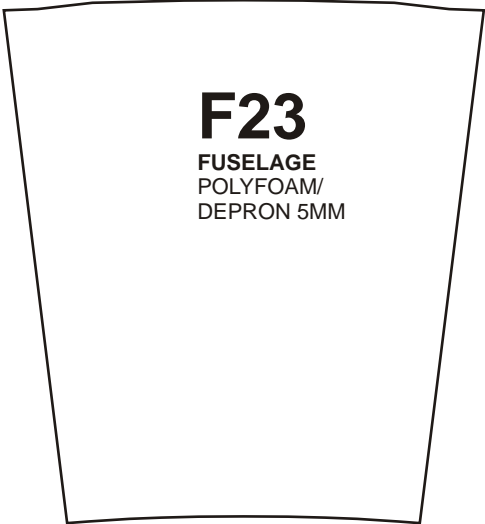
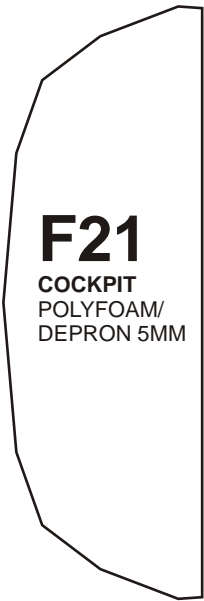
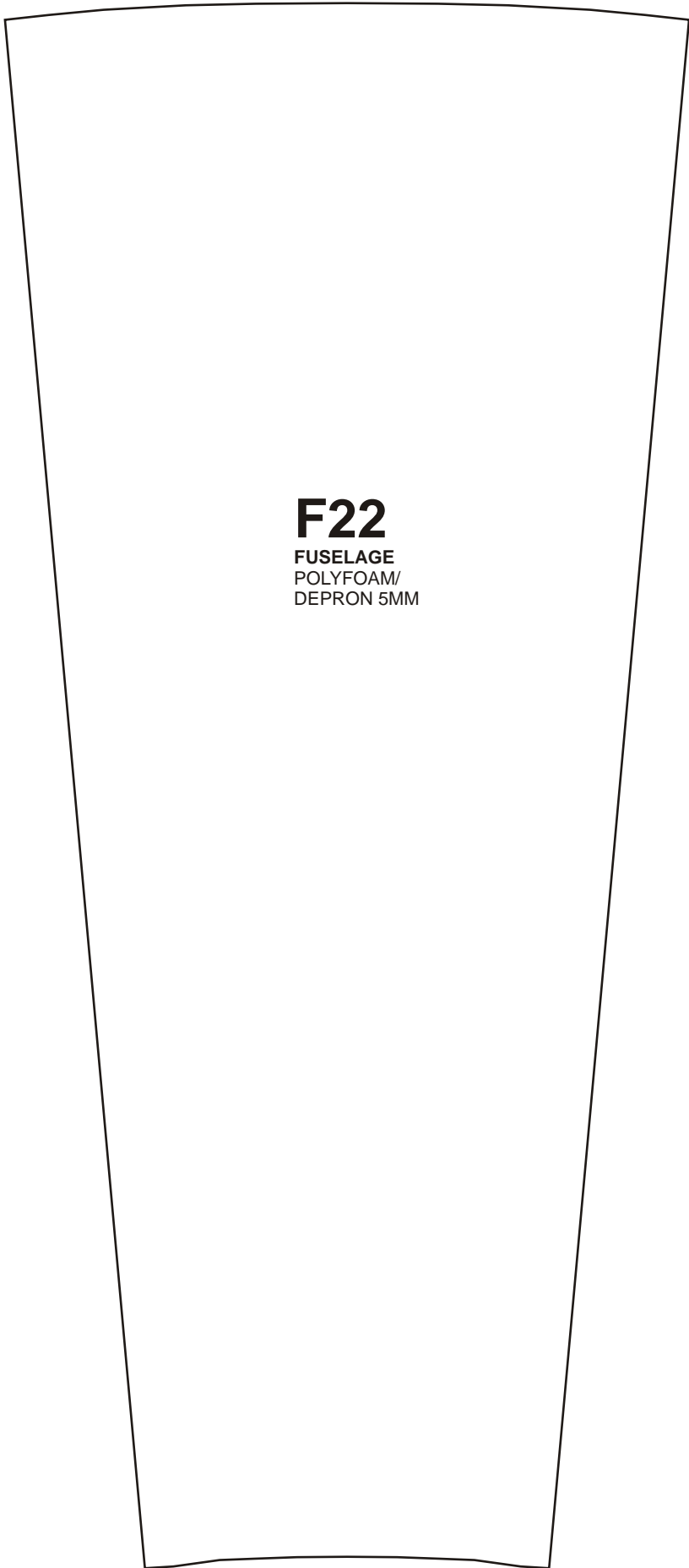

**S1**

**HORIZONTAL STABI**  
POLYFOAM/  
DEPRON 5MM

**S3**

**RUDDER**  
POLYFOAM/  
DEPRON 5MM

**S2**

JOIN HERE

JOIN HERE

JOIN HERE

JOIN HERE

**S1**

**S2**

VERTICAL STABI  
POLYFOAM/  
DEPRON 5MM

**S5**

ELEVATOR  
POLYFOAM/  
DEPRON 5MM

**S4**

ELEVATOR  
POLYFOAM/  
DEPRON 5MM  
2X

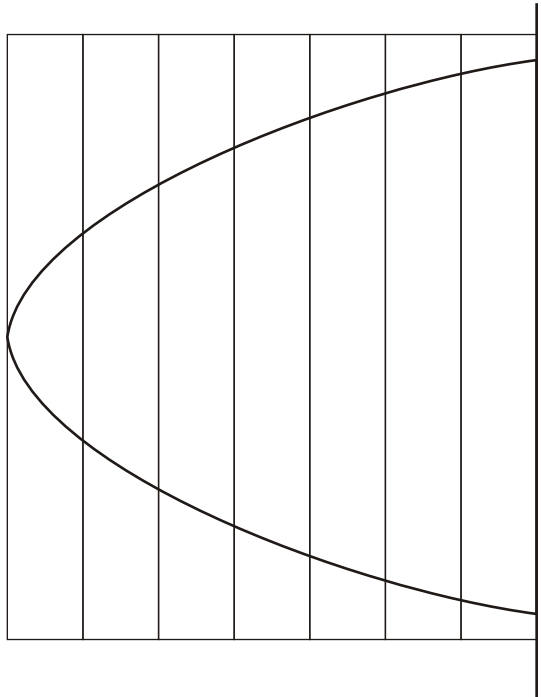
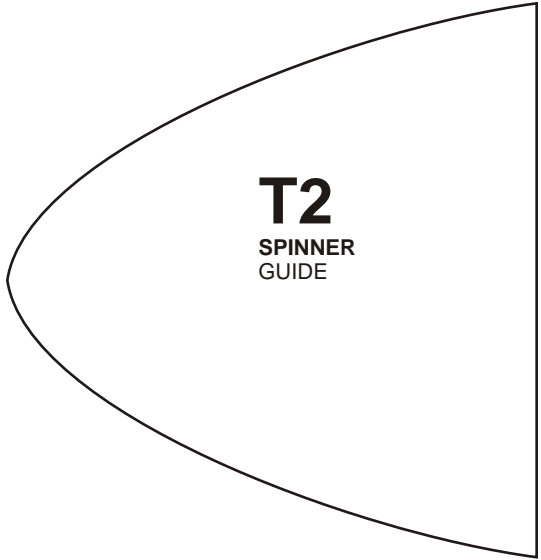



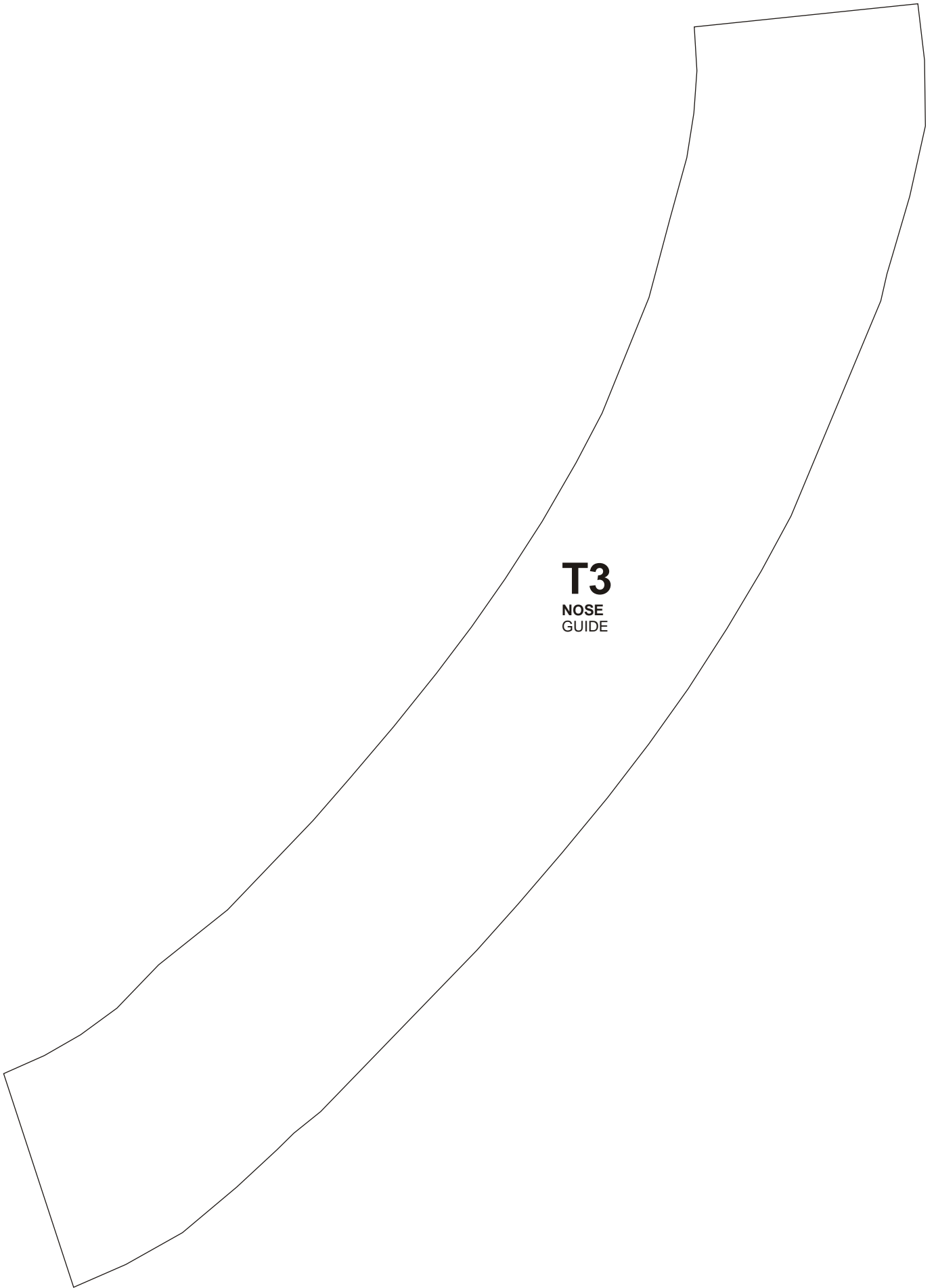

**T3**  
NOSE  
GUIDE

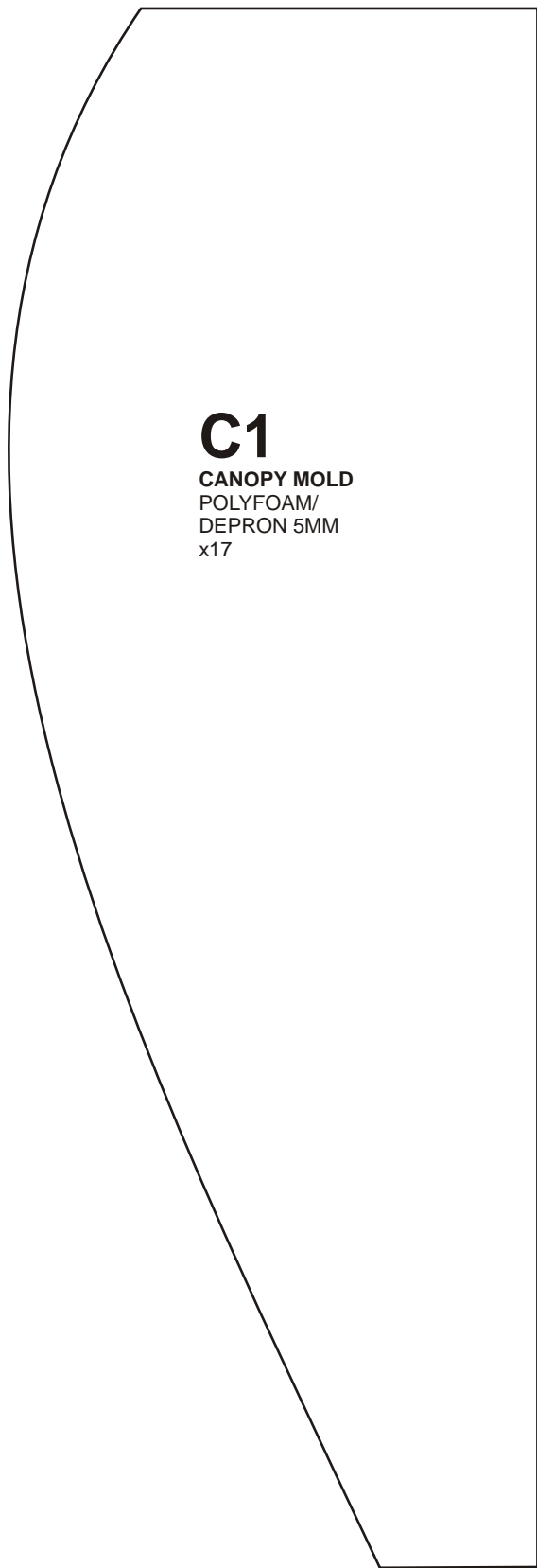

**C1**  
CANOPY MOLD  
POLYFOAM/  
DEPRON 5MM  
x17

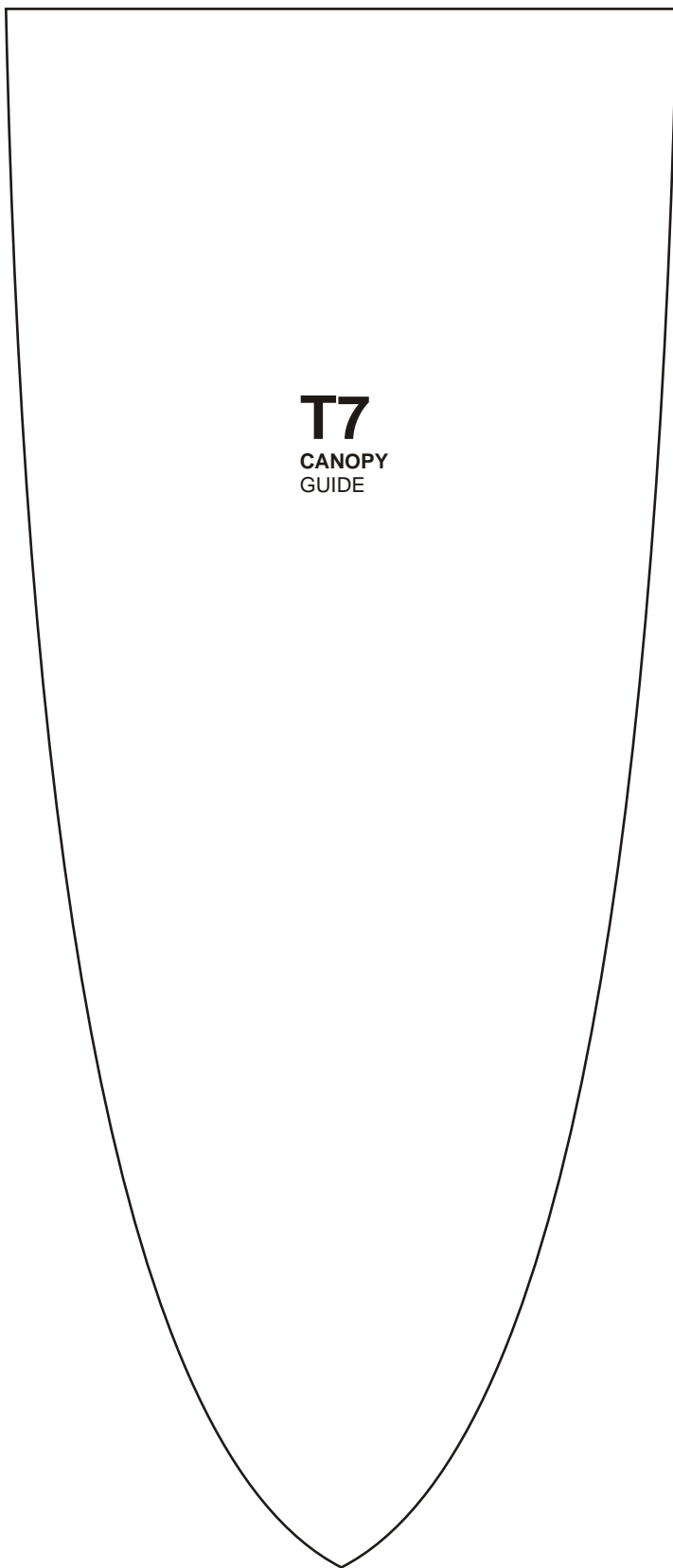

**T7**  
CANOPY  
GUIDE

JOIN HERE

**F24**

WING FAIRING  
POLYFOAM/  
DEPRON 5MM  
2X MIRRORED

**F25**

2X

**F24**

**F31**

EXHAUST  
MICA PLASTIC 0.3MM

JOIN HERE

**T5**  
CANOPY  
GUIDE

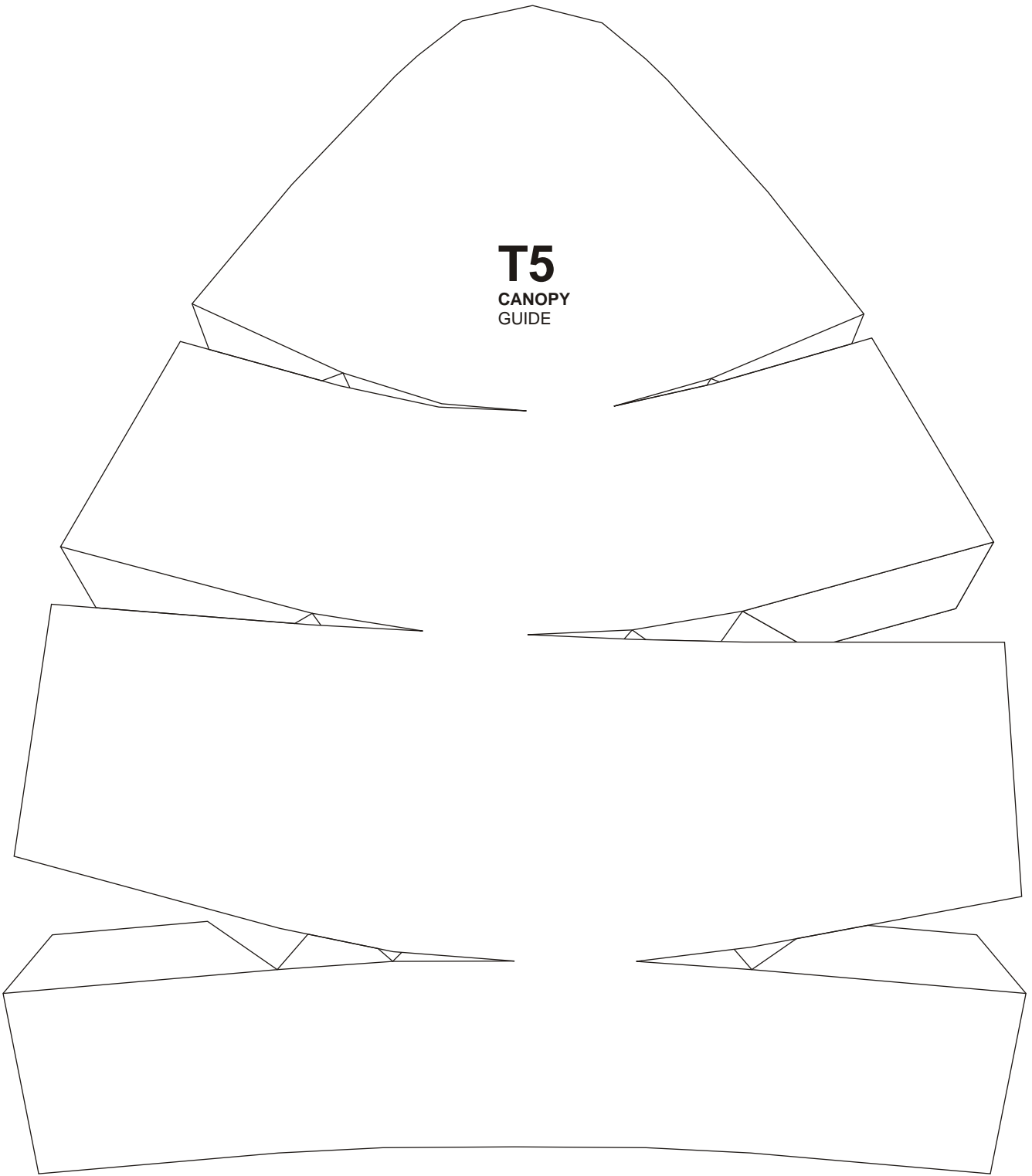

D6

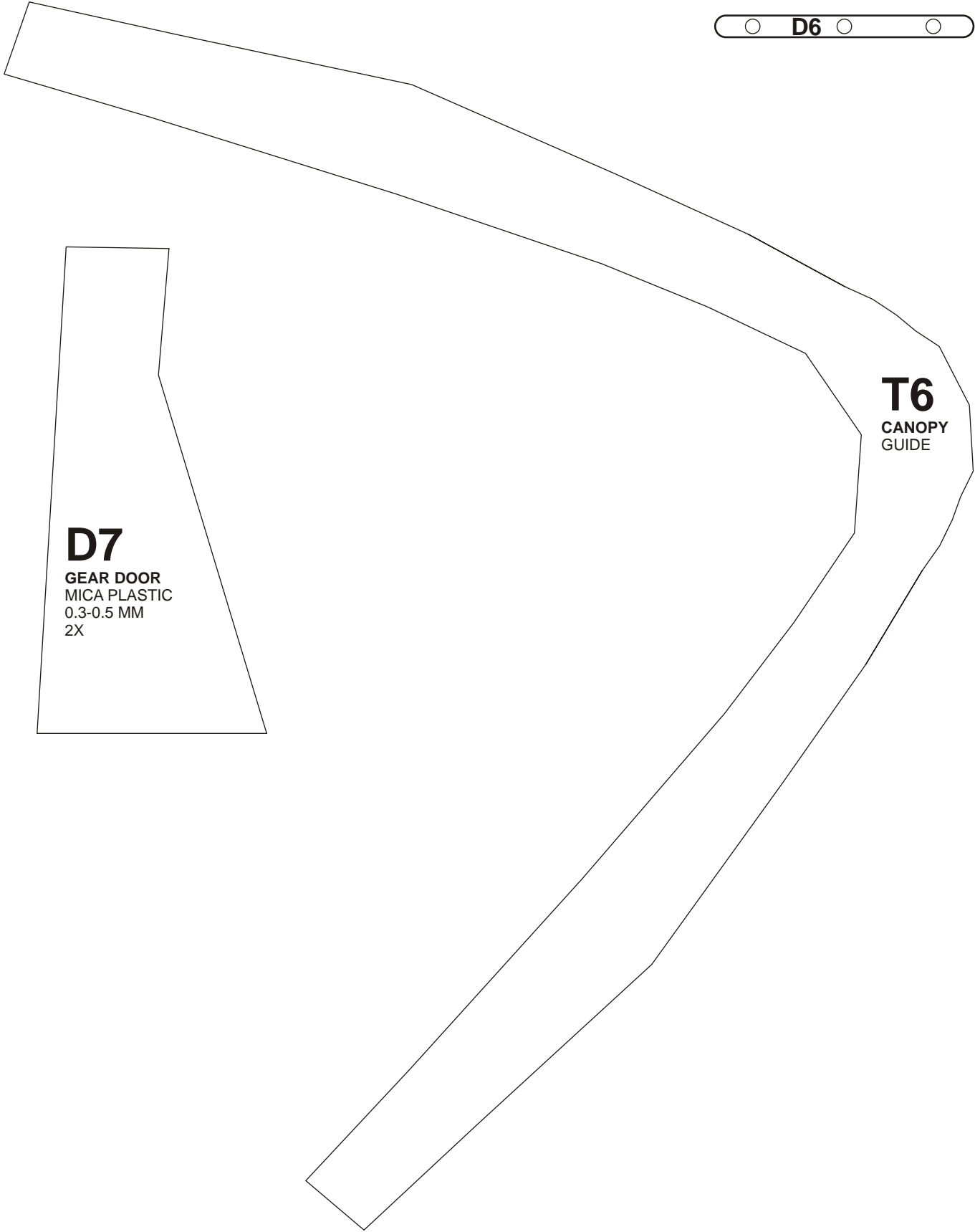

**T6**  
CANOPY  
GUIDE

**D7**

GEAR DOOR  
MICA PLASTIC  
0.3-0.5 MM  
2X

