



PZL-104 WILGA

1400mm

Specs :

1. Wingspan 1400mm / 55 inches
2. Flying weight : 900 grams/ 31.7 oz
3. Wing loading : 35.7 g/dm² - 11.7 oz/sq.ft
4. Wing cube loading : 7.1
5. Wing Area : 25.2 dm² / 391 sq.in
6. CG : 5.25 cm from LE

Electronics

- Turnigy 2830 1000kv brushless motor
- ESC 40A
- Battery Lipo 3S 2200mah - Li-ion 3S 3300 mah
- 4 plastic gear 9 gram servos
- Propeller : 10x5

Materials :

1. 5mm & 10mm Depron/ Polyfoam
2. 3mm Plywood
4. 0.3mm Mica Plastic
5. hot glue + CA glue
6. white packing tape

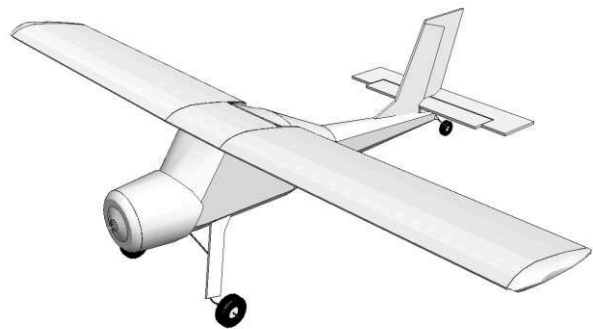

Build Instructions :

1. paper-replika.com
2. youtube channel : Julius Perdana

SPAR POSITION

W1

MIDDLE WING BASE
POLYFOAM/ DEPRON 5MM

W2

AIRFOIL FORMER
POLYFOAM/ DEPRON 5MM
6X

W3

MIDDLE WING SPAR
POLYFOAM/ DEPRON 5MM

T1

MIDDLE WING GUIDE
TRACE IT WITH PEN

W4

MIDDLE WING TOP
POLYFOAM/ DEPRON 5MM

SPAR POSITION

W5

WING BASE
POLYFOAM/ DEPRON 5MM
2X MIRRORED

JOIN HERE

JOIN HERE

W5

JOIN HERE

JOIN HERE

W5

W7

WING TOP
POLYFOAM/ DEPRON 5MM
2X MİRRORED

JOIN HERE

JOIN HERE

W6

JOIN HERE

JOIN HERE

W6

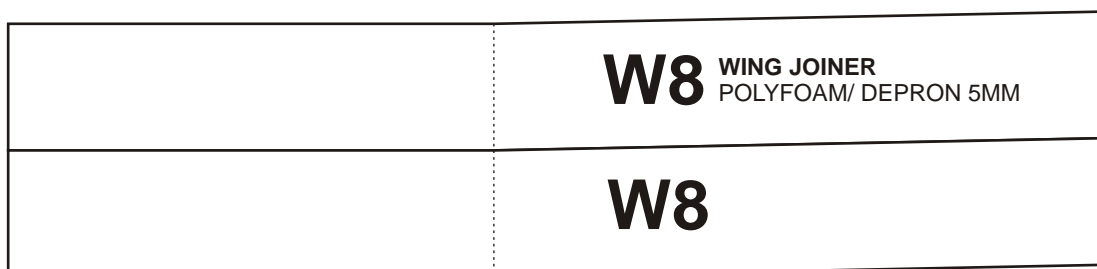

T2
WINGTIP
TRACE IT WITH PEN

T3

AILERON
TRACE IT WITH PEN

F2

FIREWALL
PLYWOOD 3MM
DOUBLE WITH 5MM FOAM

F1

LEFT FUSELAGE WALL
POLYFOAM/ DEPRON 5MM

JOIN HERE

JOIN HERE

F1

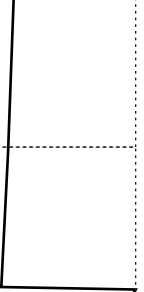



F25

FUSELAGE
POLYFOAM/ DEPRON 5MM

F4

RIGHT FUSELAGE WALL
POLYFOAM/ DEPRON 5MM

JOIN HERE

JOIN HERE

F4

F5

NOSE SECTION
POLYFOAM/
DEPRON 5MM

F6

FUSELAGE
POLYFOAM/
DEPRON 5MM

JOIN HERE

WING SPAR
POLYFOAM/ DEPRON 5MM
2X MIRRORED

W6

JOIN HERE

JOIN HERE

W6

JOIN HERE

F6

JOIN HERE

W6

JOIN HERE

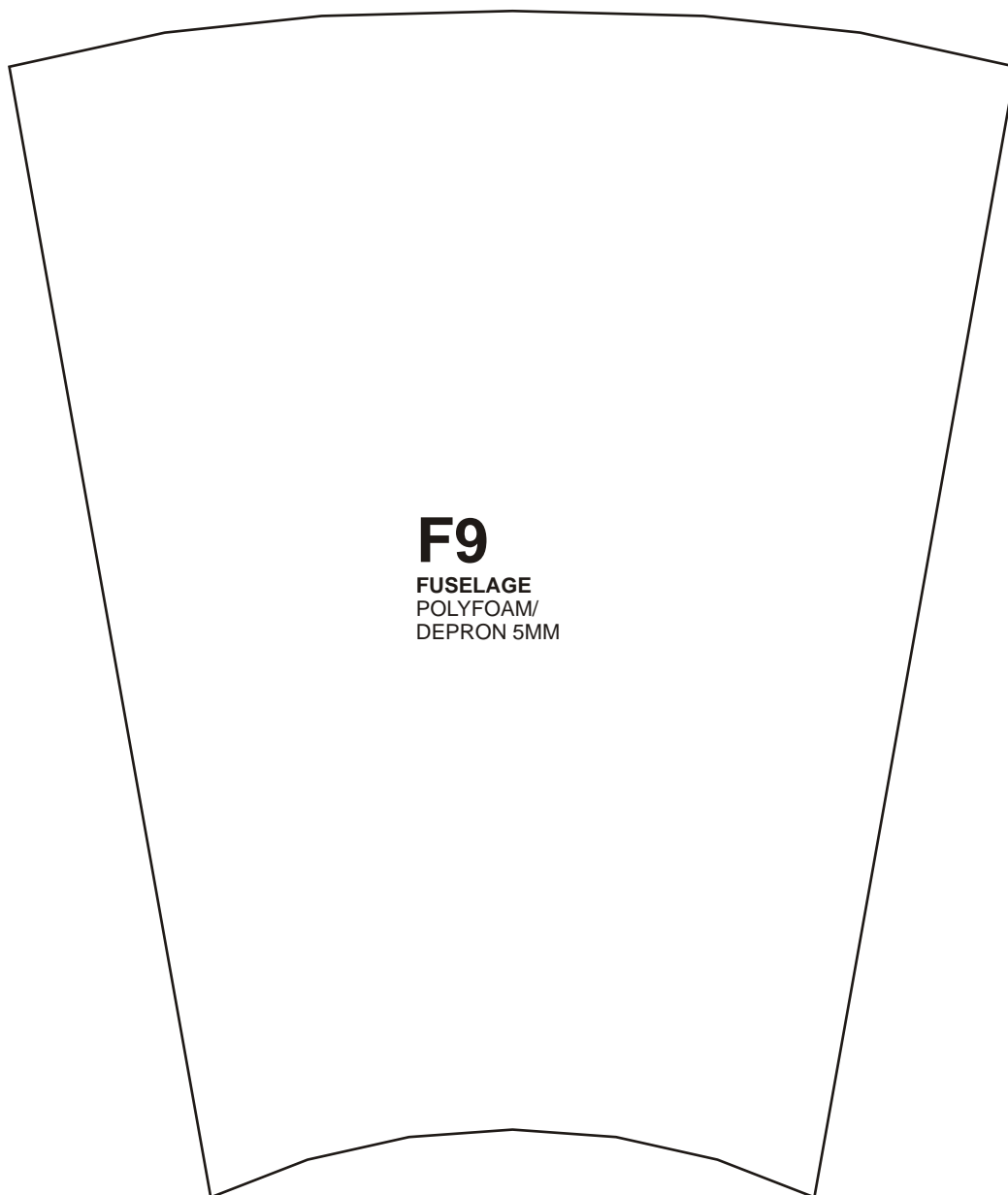

F9
FUSELAGE
POLYFOAM/
DEPRON 5MM

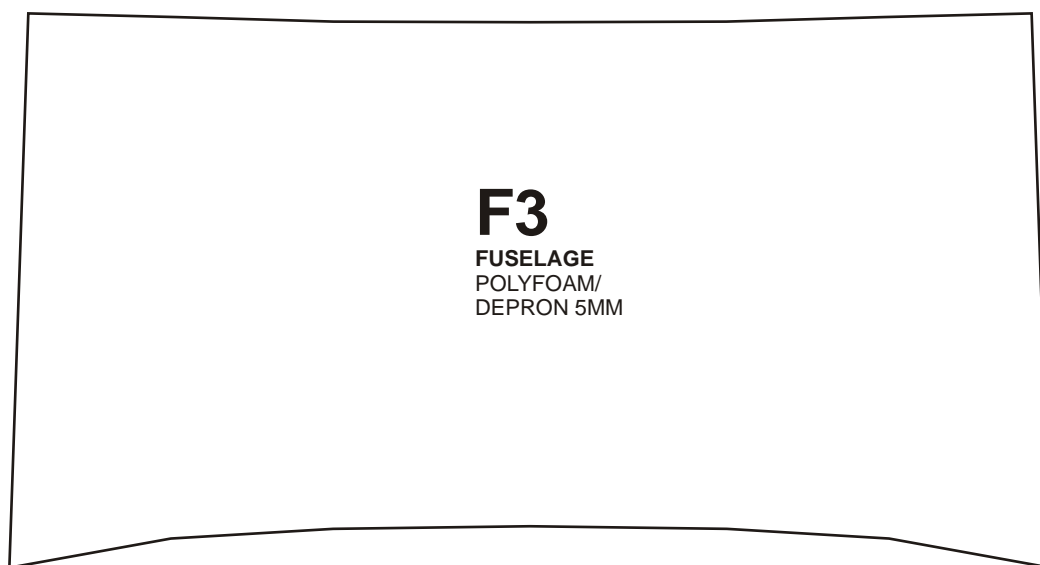

F3
FUSELAGE
POLYFOAM/
DEPRON 5MM



FRONT

F7

FUSELAGE
POLYFOAM/
DEPRON 5MM



FRONT

F8

FUSELAGE
POLYFOAM/
DEPRON 5MM



FRONT

F17

FUSELAGE
POLYFOAM/
DEPRON 5MM



FRONT

F15

FUSELAGE
POLYFOAM/
DEPRON 5MM



FRONT

F16

FUSELAGE
POLYFOAM/
DEPRON 5MM



FRONT

F14

FUSELAGE
POLYFOAM/
DEPRON 5MM

F11

FUSELAGE
POLYFOAM/
DEPRON 5MM

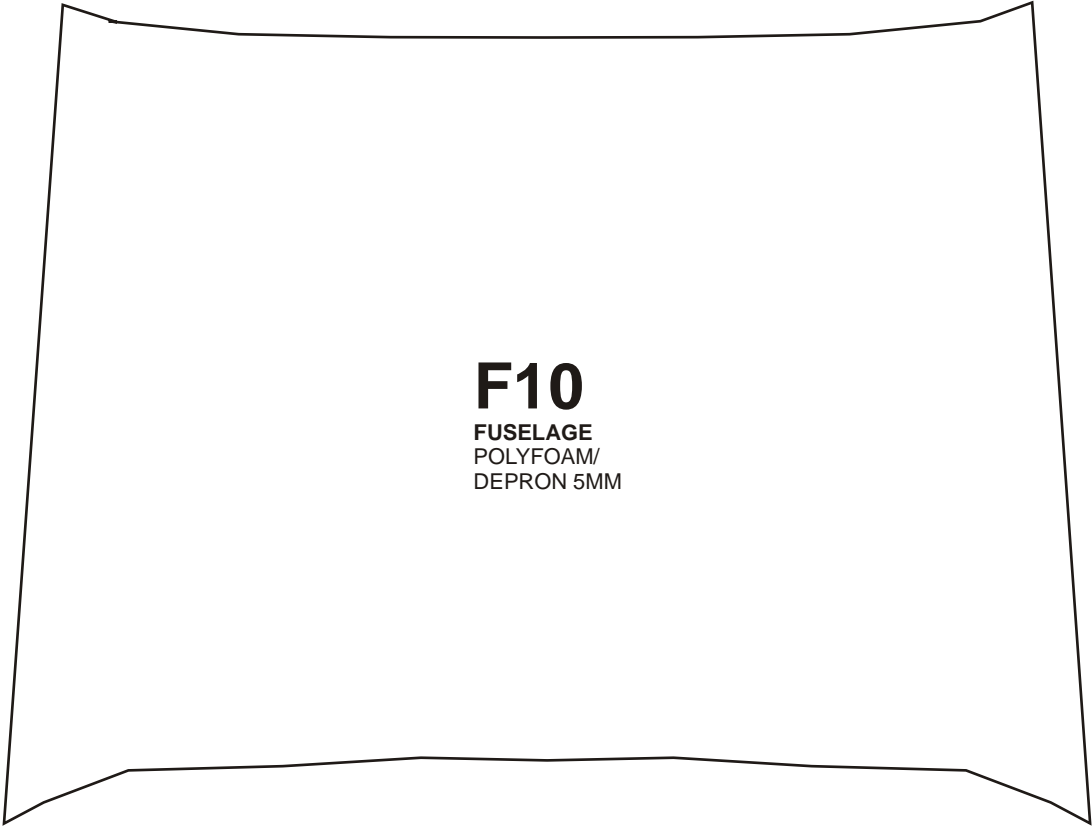

F10

FUSELAGE
POLYFOAM/
DEPRON 5MM

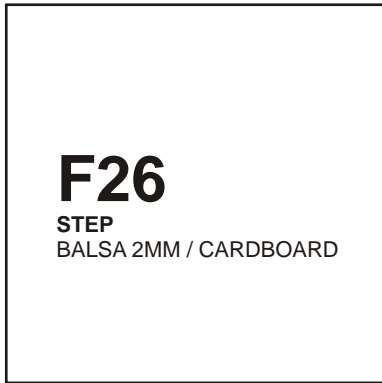

F26

STEP
BALSA 2MM / CARDBOARD



F26



F20

JOIN HERE



F18

JOIN HERE

F21

JOIN HERE

JOIN HERE

JOIN HERE

JOIN HERE

F19

F20

F18

F21

S3

RUDDER
POLYFOAM/ DEPRON 5MM



F22

TAIL SECTION
POLYFOAM/
DEPRON 5MM

JOIN HERE



F23

TAIL SECTION
POLYFOAM/
DEPRON 5MM

JOIN HERE

F24

TAIL SECTION
POLYFOAM/ DEPRON 5MM

JOIN HERE

JOIN HERE

F22

JOIN HERE

F24

JOIN HERE

F23

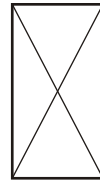
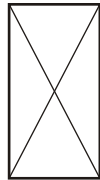

F26

SERVO PLATFORM
POLYFOAM/ DEPRON 5MM

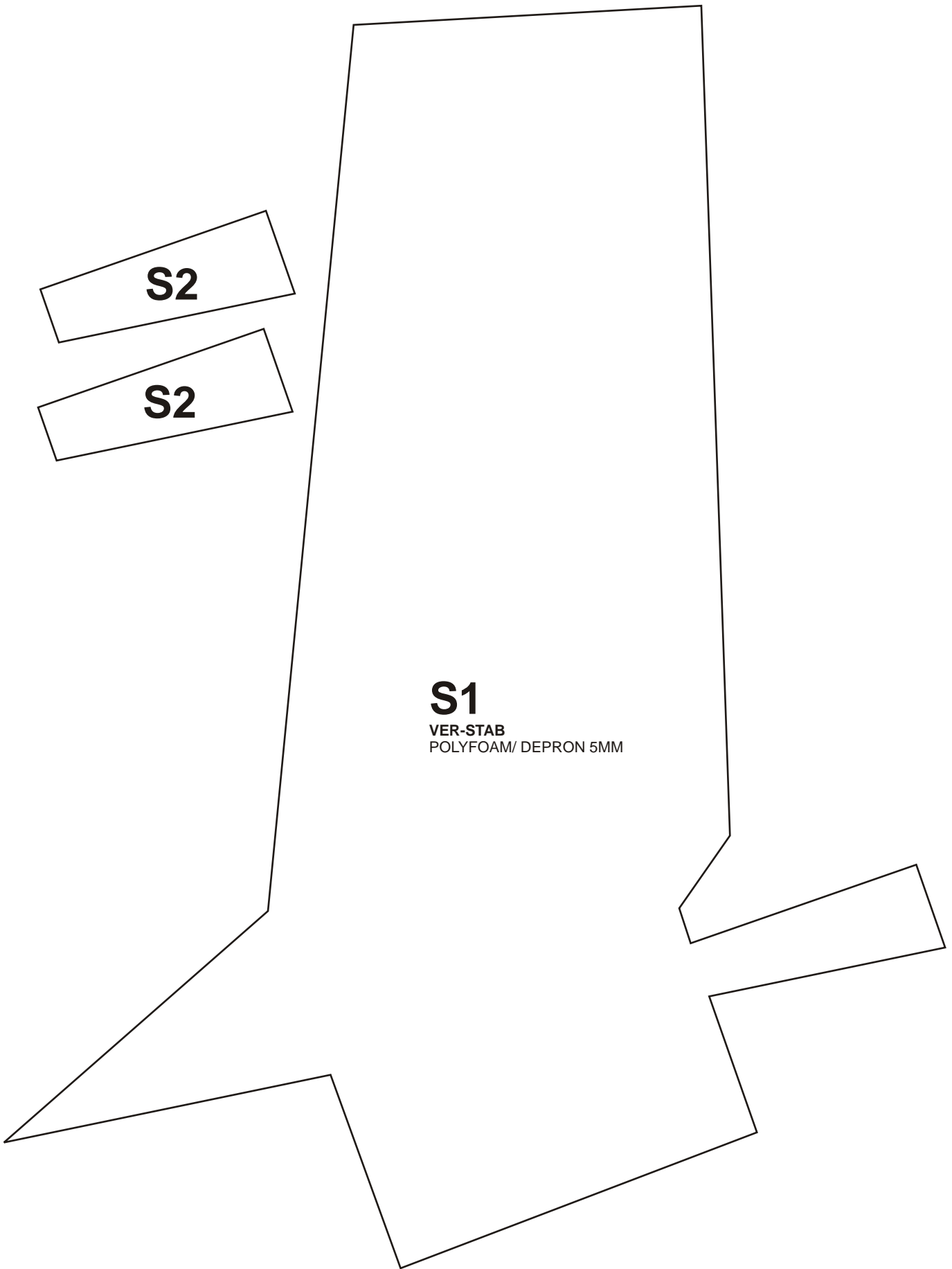

S2

S2

S1

VER-STAB
POLYFOAM/ DEPRON 5MM

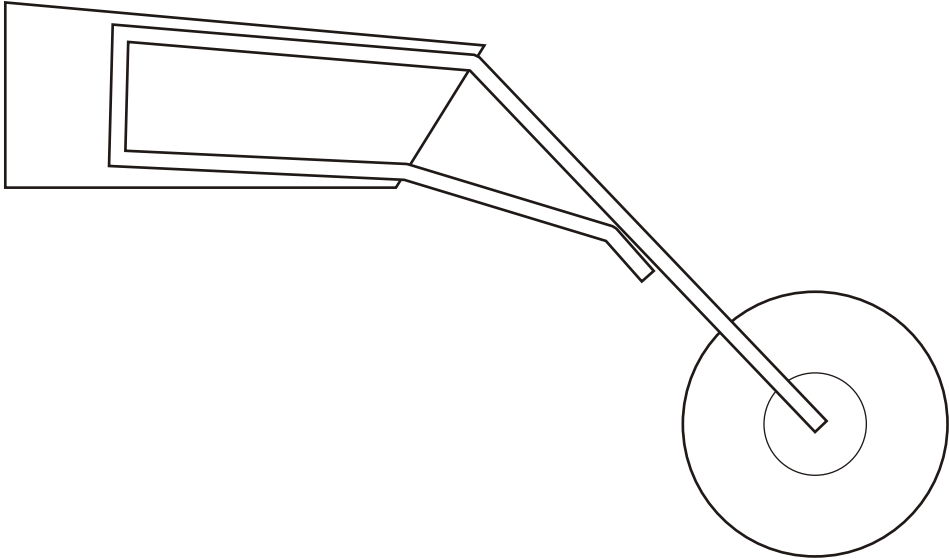
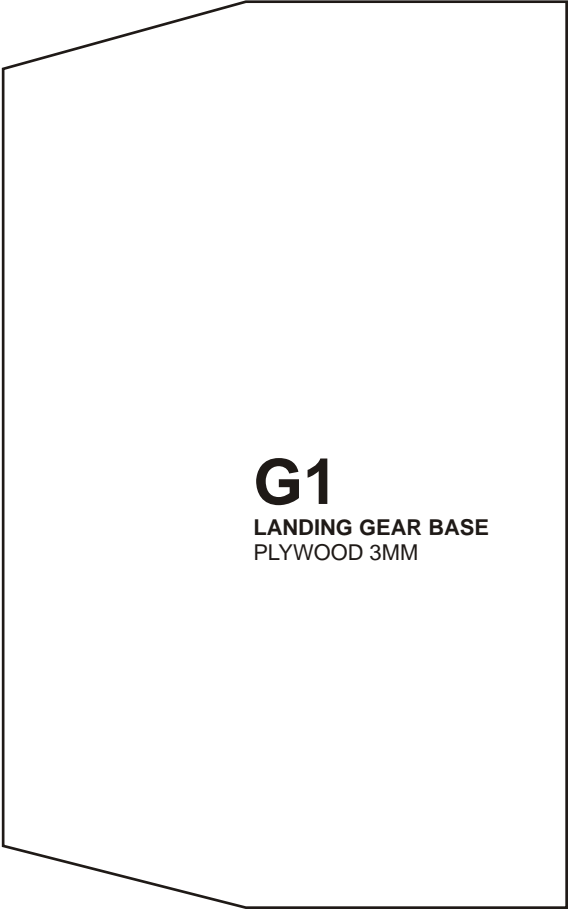
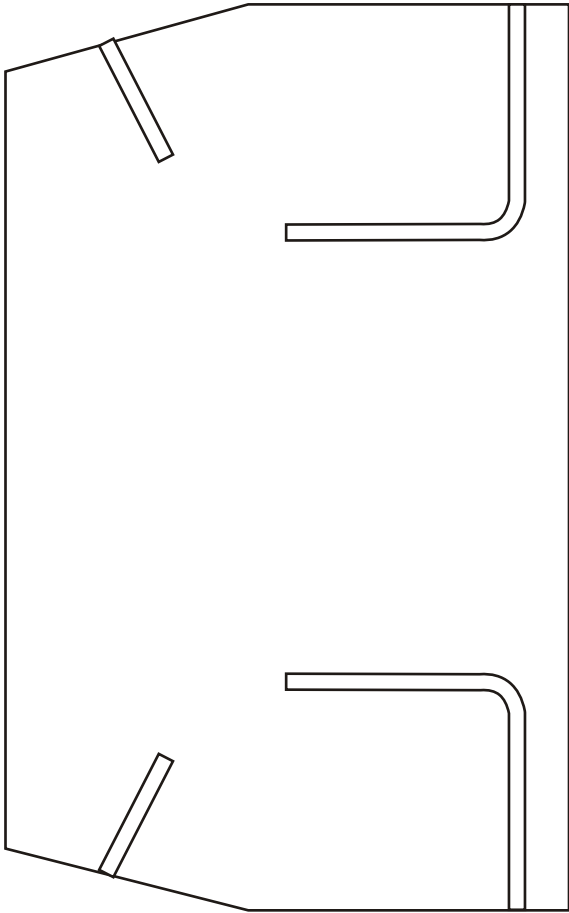

LANDING GEAR STRUT

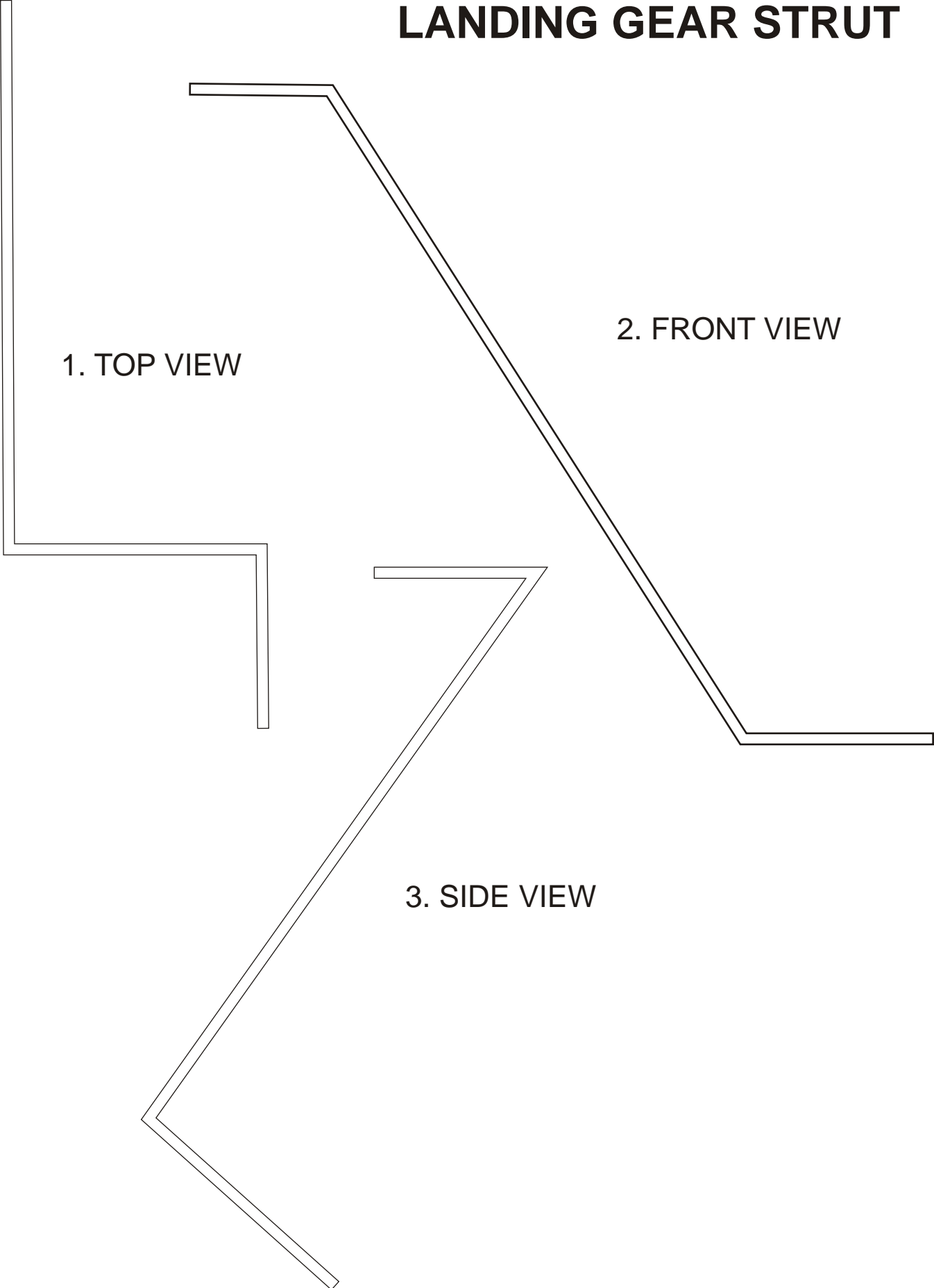

1. TOP VIEW

2. FRONT VIEW

3. SIDE VIEW

S5

ELEVATOR
POLYFOAM/
DEPRON 5MM

JOIN HERE

S4

HOR-STAB
POLYFOAM/
DEPRON 5MM

JOIN HERE

JOIN HERE

JOIN HERE

S4

S5

G3

LANDING GEAR FAIRING
PLYWOOD 3MM



C1

ENGINE COWL
MICA PLASTIC 0.3 MM

JOIN HERE

JOIN HERE

C1

ENGINE COWL
POLYFOAM/ DEPRON 5MM
3X

C2

C3

